

Uniden®

UBCD996T

Owner's Manual

OWNER'S MANUAL



Precautions

Before you use this scanner, please read and observe the following.

EARPHONE WARNING!

Be sure to use only a monaural earphone or 32 Ω stereo headset. Use of an incorrect earphone or stereo headset might be potentially hazardous to your hearing. The output of the phone jack is monaural, but you will hear it in both headphones of a stereo headset.

Set the volume to a comfortable audio level coming from the speaker before plugging in the monaural earphone or a stereo headset of the proper impedance (32 Ω). Otherwise, you might experience some discomfort or possible hearing damage if the volume suddenly becomes too loud because of the volume control or squelch control setting. This might be particularly true of the type of earphone that is placed in the ear canal.

WARNING!

Uniden **does not** represent this unit to be waterproof. To reduce the risk of fire or electrical shock, **do not** expose this unit to rain or moisture.

Astro[®], DPL[®], Digital Private Line[®], Motorola[®], PL[®], PRIVACY PLUS[®], Private Line[®], SMARTNET[®], and SMARTZONE[®] are registered trademarks of Motorola, Inc.

LTR[®] is a registered trademark of E.F. Johnson Co.

EDACS[®] is a registered trademark of M/A-COM Private Radio Systems Inc.

Other trademarks used throughout this manual are the property of their respective holders.



Power Related Issues

Important: To prevent memory from being corrupted, do not unplug the AC adapter during the time the memory is accessed for programming or auto store.

Notes:

- If when you connect the AC adapter the **[VOL] /Power Switch** is **ON**, the scanner may not power on. Should this occur, simply turn the control **OFF**, then **ON** again.
- If the scanner loses power (as when you turn off your car's ignition with the scanner's power switch on), it can lose some system settings such as display color and backlight. To ensure that such settings persist, either change the setting using the scanner's menu or power the scanner off then back on using the power switch after making such setting changes.
- When you turn off the scanner using the power switch, the scanner remembers the last settings and mode. When you turn power back on, it resumes the previous mode.



Table of Contents

Precautions	2
Power Related Issues	3
Introduction	11
Feature Highlights	12
General	12
GPS	14
Search	15
Auto Store	15
Priority	15
PC Control and Cloning	15
Memory Storage Limits	16
Search Lockout Limits	17
About This Manual	17
Using the Scroll Control [FUNC]	17
How the Scanner's Controls Are Represented in This Manual	18
Entering Text Within A Menu Option	18
A Short User's Guide to Assist the First-Time Scanner Enthusiast and Glossary	19
Understanding Scanning and the UBCD996T	21
Understanding the Scanner's Memory	21
Understanding Quick Keys	21
What is Scanning?	22
What is Searching?	22
What is CTCSS/DCS?	22
Conventional Scanning	23
Simplex Operation	23
Repeater Operation	24
What is Trunk Tracking?	24
Trunked Scanning	25
Types of Trunking Systems	25
Motorola Trunking	25
EDACS Trunking	26
LTR Trunking	27
Startup Configuration	28
Setup/Operation	28
Multi-Site Trunking	28
I-Call (Motorola/EDACS)	29
Where To Get More Information	29
Information On The Internet	29



Included With Your Scanner	30
Setting Up Your Scanner	31
Base Station	31
Setting Up an Audio Recording Device or Computer Recording	33
Vehicle Installation	33
Mounting Using the Bracket	33
Mounting Using the DIN-E Sleeve	34
Removing the Scanner from the DIN-E Sleeve	36
Mounting Using ISO Technique	36
Removing the Display Sticker	37
Connecting an Optional Antenna	37
Connecting an Earphone/Headphone	37
Connecting an Extension Speaker	38
Controls, Keys, and Functions	39
A Look At The Display	44
Operation	45
Turning On the Scanner and Setting the Squelch	45
Startup Key Operation	45
Conventional	45
Trunked	45
Search Range	45
Scanning Systems	46
Selecting Systems to Scan	47
Selecting System Channel Groups	47
Locking/Unlocking Systems	48
Locking/Unlocking Channels	48
ID Scan/ID Search Mode	48
Holding On a System	49
Holding On a Channel	49
Quickly Storing an ID During ID Search	49
Quick-Storing Channels or Talk Group ID's (TGID)	49
Trunking Activity Indicators	50
Toggling the Display Mode	51
Optimizing P25 Performance	52
Conventional System	52
Trunked System	52
Using the Menu	54
Programming General Settings	55
Setting and Using the Backlight	55
Setting the Dimmer	55
Setting the Backlight Color	56
Adjusting the Key Beep	56
Setting the Audio AGC	56
Setting the Display Orientation	57
Adjusting the Display Contrast	57



Setting the GPS Format	57
Setting the Position Format	57
Setting the Time Format	58
Setting the Time Zone	58
Setting the Distance Units	58
Setting the Serial Port Speed	58
Displaying Scanner Information	59
Viewing Memory Used	59
Viewing the Firmware Version and Electronic Serial Number	59
Initializing the Scanner's Memory	59
Connecting Your Scanner to a Personal Computer	60
Volume/Squelch with PC Control	60
Wired Cloning	60
Programming Your Scanner	62
System Settings	63
System Options	63
Site Settings	65
Channel Settings	66
Programming Conventional Systems	66
Programming Trunked Radio Systems	67
Programming System Settings	67
Editing the System Name	67
Specifying the Correct System Type	68
Programming System Options	68
Programming Sites	76
Programming Channel Groups	83
Setting Up a Channel Group	83
Editing a Channel Group Name	83
Setting the Group Quick Key	84
Editing Channels	84
Locking Out Channel Groups	84
Deleting Channel Groups	85
Programming Channels	85
Creating a Channel	85
Editing the Channel Name (Alpha Tag)	85
Editing Frequencies	86
Editing the Talk Group ID	86
Setting the Audio Type	87
Selecting CTCSS/DCS Tones	87
Quick CTCSS/DCS Save	88
Setting Channel Modulation Method	88
Setting Channel Attenuation	89
Setting Channel Priority	89
Setting Channel Alert	90
Set Record	90

Searching and Storing	92
Service Search	92
Quick Search	93
Custom Search	93
Editing a Custom Search Range	94
Search With Scan	95
Set Delay Time	96
Set Attenuator	97
Set Record	97
Assigning a Search Range to a Search Key	97
Saving a Found Channel (Quick Save)	97
Auto Search and Store	98
Selecting a System	98
Conventional Search and Store	98
Trunked Search and Store	99
Using the Close Call Feature	100
Setting Close Call Options	100
Close Call Hits	102
Close Call Hits with Scan	102
Search and Close Call Options	104
Managing Locked-Out Frequencies	104
Unlocking All Frequencies	105
Reviewing Locked-Out Frequencies	105
Searching for Subaudible Tones	105
Screening Out Broadcast Sources	105
Finding Repeater Output Frequencies	106
Setting the Maximum Auto Store Value	107
Setting the Modulation Type	107
Setting Attenuation	108
Setting Data Skip	108
Setting the Delay Time	109
Setting the Search Frequency Step	109
Setting Record	109
Adjust P25 Level	109
Priority Scan	110
Fire Tone-Out	114
Setting Tone-Out Standby	114
Setting Up Tone-Out	114
Tone-Out Multi-Channel Monitoring	116
Location-Based (GPS) Scanning	117
GPS Compatibility	117
Connecting Your Scanner to a GPS Device	117
Initial GPS Operation	117
Non-Radio Location Based GPS Features	119
Setting the Options	120
Deleting a Location	121
For POI Only	121
GPS Display Mode	122
GPS Review Location Mode	123

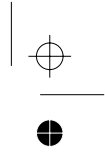
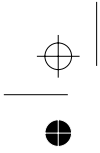

Care and Maintenance	125
General Use	125
Location	125
Cleaning	125
Birdies	125
Troubleshooting	126
Specifications	129
Reference	132
Preset Fleet Maps	132
User Defined Fleet Maps	134
Type I Programming Information	134
Size Code Restrictions	135
Preprogrammed Systems with Quick Keys	137
CTCSS Frequencies	138
DCS Codes	138
Index	140
One-Year Limited Warranty	144

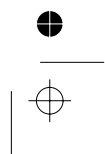
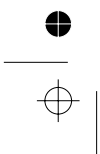

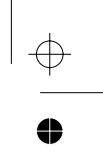
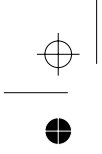

This page is intentionally blank.

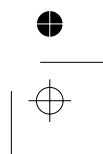
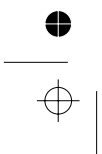

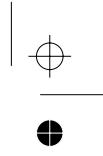
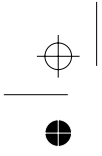

This page is intentionally blank.

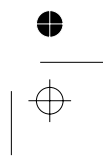
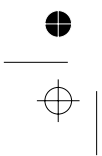

Introduction

Your UBCD996T scanner is a state-of-the-art scanner radio with Trunk Tracker IV™ and automatic scanning capabilities. You can store in the dynamic memory conventional frequencies such as police, fire/emergency, marine, air, amateur, and other communications. You can store and scan services that use Trunked Radio Systems and so much more. You can use the scanner's Scroll Control to quickly select channels and frequencies, and you can automatically program channels in a system using the Auto Store feature. Use your scanner to monitor:

- Analog and digital trunked public safety systems (unencrypted only)
- Police and fire departments (including rescue and paramedics)
- Business/Industrial radio and utilities
- Marine and amateur (ham radio) bands
- Air band
- Railroad
- UHF CB Radio
- CB Radio

Your scanner can monitor the following bands

Frequency (MHz)			
Lower Edge	Upper Edge	Modulation	Step (kHz)
25.0000	27.9950	AM	5.0
28.0000	69.9900	FM	10.0
70.0000	87.9875	FM	12.5
88.0000	107.9000	FMB	100.0
108.0000	136.9875	AM	12.5
137.0000	147.9950	FM	5.0
148.0000	173.9875	FM	12.5
174.0000	224.9000	WFM	100.0
225.0000	399.9500	AM	25.0
400.0000	512.0000	NFM	6.25
764.0000	775.9875	NFM	12.5
794.0000	805.9875	NFM	12.5
806.0000	956.0000	NFM	12.5
1240.0000	1300.0000	NFM	12.5

Note: The scanner's frequency coverage is not continuous.



Feature Highlights

General

Close Call™ RF Capture Technology — Lets the scanner detect and automatically tune to nearby radio transmissions. See “Using the Close Call Feature” on Page100 for more information.

Close Call Do-Not-Disturb — When set, the scanner makes periodic Close Call checks whenever the scanner is not receiving audio in another mode. This eliminates the annoying breaks in conversation while still allowing for Close Call functionality.

Close Call Temporary Store — Temporarily saves the last 10 Close Call hits and includes them when scanning.

Dynamically Allocated Channel Memory — Your scanner’s 6,000 channels are organized so that it more closely matches how radio systems actually work, making it easier to program and use your scanner and determine how much memory you have used and how much you have left.

Preprogrammed Systems — Your UBCD996T may come pre-programmed with local systems (for Australian and NZ Emergency Services for example) as a complementary start.

100 Quick Keys — You can set the scanner so you can quickly select systems and groups by using the keypad. This makes it easy to listen to or quickly lock out those systems or groups you don’t want to scan.

9 Service Searches - frequencies are preset in separate Police, Marine, Railroad, Air, CB Radio, UHF CB Radio, Racing, TV Broadcast, and FM Broadcast searches, to make it easy to search and scan for specific transmissions.

“Soft” Search Keys — Lets you quickly search specified ranges.

Channel Lockout — You can lock out any system, group, frequency, or channel while scanning. If you lock out a system or group, any channels belonging to that system or group are also locked out.

Frequency Lockout — You can lock out up to 500 frequencies (250 permanently locked out + 250 temporarily locked out). The scanner skips locked-out frequencies while using the Close Call™ feature or while searching.

CTCSS and DCS Squelch Modes — Prevent interference from stations not using the tone code you select.

Analog and Digital Audio AGC — Helps automatically balance the volume level between different radio systems.





Fire Tone-Out Standby — Lets you set the scanner to alert you if a two-tone sequential page is transmitted. You can set up to 10 settings (transmit frequency, tone frequencies) then select one for standby monitoring. Up to ten tone-outs on the same RF setting can be scanned at one time.

Broadcast Screen — Sets the scanner to ignore Close Call™ or search hits on known broadcast frequencies including common pager frequencies.

Custom Screen — Lets you input up to 10 frequency ranges that the scanner will ignore during Close Call™ or search operation.

Scan/Search Delay — The scanner pauses at the end of a transmission to wait for a reply. You can set the delay time for each system you scan, and while searching and using the Close Call™ feature.

Attenuator — Reduces the input strength of strong signals by about 20 dB.

Repeater Reverse — Automatically switches to the input frequency on a conventional repeater system.

Channel Alert — Alerts you when there is activity on any channel you specify using your choice of nine unique alert tones.

Memory Check — Lets you see at a glance how much total memory is left.

Search with Scan Operation — Lets you include selected service searches or custom search ranges during normal scan operation.

Custom Alerts — For each alert in the scanner (such as channel alert, Close Call alert, emergency alert), you can select from 9 different tone patterns and also set the alert volume level independently from the main volume level.

Automatic Channel Step — Accepts frequencies on any valid channel step, even if it does not fall within the band plan's default step.

Frequency Step — Lets you select a frequency step (5, 6.25, 7.5, 8.33, 10, 12.5, 15, 20, 25, 50 or 100 kHz) for manual mode and search mode.

Text Tagging — You can name each system, group, channel, talk group ID, custom search range, and custom search range, using up to 16 characters per name.

Data Skip — Allows your scanner to skip unwanted data transmissions and reduces the affect of birdies.

Duplicate Frequency Alert — Alerts you if you try to enter a duplicate name or frequency already stored in a system.





Memory Backup — If power is lost or disconnected, the scanner retains the frequencies you programmed in its memory.

Temporary Lockout — Makes it easy to temporarily lock out a system, channel, or frequency. The lockout is cleared when you turn power off, then back on so you don't have to remember to unlock the channels later.

Startup Configuration — Lets you easily manage multiple configurations for your scanner.

Single-Handed Function Control Operation — You can tap the Function/Scroll Control to enable the Function mode. It reverts to normal mode in about 3 seconds from your last press if no other action occurs.

Record Out Jack — Using the appropriate cable and audio recording device with signal control, you can record live audio of designated channels.

Display and Keypad Backlight — Makes the display and keypad easy to see in dim light using two color options and six light levels plus off.

Vehicle Power Connection (Orange Wire) — Lets you connect to your vehicle's dimmer circuit to also dim the scanner's display with the vehicle's dimmer control.

Trunk Tracker IV™ Operation — Follows unencrypted conversations on analog Motorola, Motorola Astro 25 (APCO 25), EDACS, EDACS SCAT, and LTR trunked radio systems, including systems in VHF, UHF, 700 MHz, 800 MHz, and 900 MHz bands. The scanner can scan both conventional and trunked systems at the same time.

Multi-Site Trunking — Lets you share system channels across multiple sites to more efficiently use the scanner's memory and more easily select sites to monitor.

Control Channel Only Scanning — If the scanner is set to scan a Motorola system, you can set it so it scans using only control channel data. You do not have to program voice channel frequencies into memory in this mode as long as all possible control channels are programmed.

Adaptive Digital Threshold — Automatically sets the digital decode threshold for APCO 25 systems.

GPS

Location Based Scanning — If you connect a GPS unit to the scanner it can automatically enable and disable systems based on the Location Information (longitude, latitude, Range) that you provide.

GPS Non-Radio Based Features — The scanner alerts you to Dangerous Intersections, Speed Alerts, and Points of Interest that you program into the scanner.

GPS Display Mode — Lets you display extended GPS information such as





Distance to a POI, Direction to a POI, Time to a POI, Speed, Position, and more.

Search

Service Search — Lets you quickly select and search the scanner's preprogrammed frequencies.

Custom Search — Lets you program up to 10 custom search ranges. You can search any of these ranges simultaneously.

CTCSS/DCS Search — Lets the scanner search for CTCSS or DCS tones or codes on any channel or during a search. The scanner can identify up to 50 CTCSS tones and 104 DCS codes.

Quick Search — Lets you search from the currently-tuned frequency if you are searching a conventional system.

Auto Store

Frequency AutoStore — Automatically stores all active frequencies into the selected conventional system.

Talk Group ID AutoStore — Automatically stores all new talk group ID's into a channel group you select.

Priority

Priority Scan — Priority channels let you keep track of activity on your most important conventional channel(s) while monitoring transmissions on other channels.

Priority Plus — You can set the scanner so it scans only the priority channels.

PC Control and Cloning

PC Control — You can transfer programming data to and from your scanner and your personal computer, and control the scanner using a computer. This helps you find frequencies listed on the Internet and load them into the scanner. Free PC control and programming software will be available at the UBCD996T web page at www.uniden.com.au (for Australia) or www.uniden.co.nz (for New Zealand).

Clone Mode — You can clone all programmed data, including the contents of the scanner's memory, menu settings, and other parameters from one UBCD996T scanner to another UBCD996T scanner.



Memory Storage Limits

Systems	Sites	Sites in Systems	Groups in System	Total Channels
500	1000	256	20	6000

Channels in Conventional Systems	Channels in Trunked Systems	Trunked Frequencies In Site*
1000	250	750-1000

* depending on the number of TGID in the system.

Search Lockout Limits

Frequency	Temporary L/O Frequency	Permanent L/O Frequencies	Skipped	Review
500	250	250	Search Mode Close Call Mode	Menu Mode

About This Manual

The screen displays used in this manual are representations of what might appear when you use your scanner. Since what you see depends on the frequencies and user IDs for your area and the settings you select, you might notice some differences between what is in this manual and what appears on your scanner. To get the most from this manual, review the contents to become familiar with the basic functions available.

Using the Scroll Control Func

The Scroll Control, a dual purpose control, also lets you switch to secondary function operations. When used in this manner, you see Func in this manual. Located prominently on the right of the UBCD996T's front panel, the knob/switch lets you easily control channel selection, plus Normal and Function Modes, as well as how most of the information appears on the display.

To adjust menu settings, change channels in Hold mode, and resume scanning: Simply turn the **Scroll Control**.

To use Func tap the **Scroll Control**. This action is written in shorthand as F which is fully explained in the next section. When you tap the control F appears and remains in the upper left corner of the display for 3 seconds. During this time, press any button to access the button's second function. Or, press and hold the Scroll Control for 2 seconds. The scanner beeps, and the Func function is "latched" so that it does not return to normal mode until you tap the Scroll Control again. F flashes at approximately 1 second intervals.

If you select Func while scanning, the UBCD996T continues to scan, but holds on the current system until the function operation is cancelled.



How the Scanner's Controls Are Represented in This Manual

To help navigate the scanner's menus, the steps shown in this manual show the displays you see and the keys you press or control you operate to get a desired result. We use a form of shorthand symbols to save space.

The following example shows you how to use the scanner's menu to edit an existing system name. It shows you the key to press in brackets **[MENU]** to select a menu option and the option you see on the LCD in Boldface Courier type (**Program System**) when you press **[MENU]**. It also instructs you to turn the **Scroll Control** (shown as **↻**) to view a series of choices then *press* or *tap* the **Scroll Control** (the shorthand action shown as **Ⓞ**) to *enter* a choice such as **Edit Name**.

[MENU] → **Program System** → **Ⓞ**
↻ Select the system → **Ⓞ**
Edit Name → **Ⓞ** Then, edit the system name.

Entering Text Within A Menu Option

To enter a letter, turn the Scroll Control (**↻**) until the letter, numeral or other character you want appears. To move the cursor to the left, press **</4**. To move the cursor to the right, press **6/>**.

To clear a character, press [.No] twice. To clear all characters, press **[.No]** three times.

To accept an entry, press or tap the **Scroll Control** or press **[EYES]**.

To cancel an entry, press **[MENU]**.





A Short User's Guide to Assist the First-Time Scanner Enthusiast and Glossary

Welcome to the family of Uniden scanner users. You have just unpacked your Uniden UBCD996T scanner. You are anxious to scan and hear something so you rotate the **[VOL/POWER]** control and wait a moment as the opening Message and Copyright screens confirm the model information.

Then, if you live in a residential area, you probably hear nothing or very little. Why?

The reason is simple. The programmable UBCD996T does not instinctively know where you are and what you wish to listen to.

Take a few minutes to assist in the 'educating your scanner' process so you can enjoy listening for the first time and feel good about your purchase.

Before proceeding, first follow the steps on Page 45 to set the volume and the squelch levels. Once set correctly, these settings let you listen at a comfortable level and let the scanner provide a signal whose strength is sufficient to be heard clearly. Always be sure to connect the provided antenna.

Uniden has made it easy for you to start scanning. We have preprogrammed the UBCD996T with local systems (for Australia and New Zealand Emergency Services). Simply press **[SCAN]** to start scanning.

Finally, you may decide to program the scanner yourself. To correctly program the UBCD996T scanner begin on Page 62. The two programming steps are

1. Plan the system
2. Program the system based on the plan.

To provide you with useful sized worksheets and instructions to complete them, we have established links at our company website.

Visit, <http://www.uniden.com/scanners> to see a list of helpful forms. But first, visit <http://www.radioreference.com> and locate the system nearest your location that you want to scan. If you register and pay a small fee, you can download a ready-to-use formatted PDF complete with the data from your selected system.

Otherwise, you can print the blank worksheet on our web page as you would any other web based page.

The programming data of a large metropolitan area may consist of many pages depending on how extensive the area's Public Service System Talkgroups are. Don't



be overwhelmed. Begin by choosing the Talkgroups of interest to you. Begin by transferring the data from the Radio Reference website to the worksheets you obtain from the Uniden website and from there, to the scanner.

You can visit one of the Radio Reference forums and potentially learn of someone in your immediate area who has programmed the same model scanner in your area. Then, by using the Clone feature or by exchanging files that you each have transferred to a computer using the Uniden Advanced Scanner Director (UASD) software you can install the programmed data into your scanner. Once you have either programmed or selected the option that lets you start experiencing scanning, spend the next few minutes learning the basics of trunk tracking for an even more complete listening appreciation.





Understanding Scanning and the UBCD996T



This section provides you with additional background on how scanning works and how your scanner provides that feature. You don't really need to know all of this to use your scanner, but some further background knowledge will help you get the most from your UBCD996T.

Understanding the Scanner's Memory

Your scanner's memory is organized in an architecture called *Dynamic Allocated Channel* memory. This type of memory is organized differently and more efficiently than the bank/channel architecture used by traditional scanners. Dynamic Allocated design matches how radio systems actually work much more closely, making it easier to program and use your scanner and determine how much memory you have used and how much you have left.

Instead of being organized into separate banks and channels, your scanner's memory is contained in a *pool*. You simply use as much memory as you need in the pool to store as many frequencies, and talk group ID's as desired. No memory space is wasted, and you can tell at a glance how much memory you have used and how much remains.

With a traditional scanner, when you program it to track a trunked system, you must first program the frequencies. Since you can only program one trunking system per bank in a traditional scanner, if there were (for example) 30 frequencies, the remaining channels in the bank are not used and therefore wasted. Also, since some trunked systems might have hundreds of talk groups, you would have had to enter those types of systems into multiple banks in order to monitor and track all the ID's.

Understanding Quick Keys

Traditional "Banked" scanners let you select and deselect banks by pressing a single digit on the keypad. The UBCD996T uses a similar method to turn on and off scanning sites and systems. When you program a system or site, you assign a quick key (System/Site Quick Key, or SQK) from 0 to 99. You can use the same quick key for multiple systems, so that the systems are turned on and off together. To turn a system/site on or off, just press the digit corresponding to the assigned SQK. For two-digit SQK's, first press **[.No]**, then enter the two-digit SQK.

The UBCD996T lets you assign another quick key to a group of channels within a system. This group quick key (GQK) can be from 0-9. To turn on and off channel groups, you press **[Func]** while the scanner is scanning the system containing the channels, then press the GQK within 2 seconds. Systems can have up to 20 channel groups, and multiple channel groups can be assigned to the same GQK.



What is Scanning?

Unlike standard AM or FM radio stations, most two-way communications do not transmit continuously. Your UBCD996T scans programmed channels until it finds an active frequency, then stops on that frequency and remains on that channel as long as the transmission continues. When the transmission ends, the scanning cycle resumes until the scanner receives another transmission.

What is Searching?

The UBCD996T can search each of its 9 service search ranges and up to 10 custom search ranges to find active frequencies. This is different from scanning because you are searching for frequencies that have not been programmed into the scanner's channels. You set the upper and the lower values of the range and then the scanner searches for any active frequency within the limits you specify. When the scanner finds an active frequency, it stops on that frequency as long as the transmission lasts. If you think the frequency is interesting, you can program it into the scanner's memory. If not, you can continue to search.

What is CTCSS/DCS?

Your scanner can monitor systems using a Continuous Tone Coded Squelch System (CTCSS) and Digital Coded Squelch (DCS) system, which allow squelch to open only when the tone you have programmed with a specific frequency is received along with a transmission.

CTCSS and DCS are sub-audible tone signaling systems sometimes referred to as PL or DPL (Motorola's trademarked terms for Private Line and Digital Private Line respectively). CTCSS and DCS are used only for FM signals and are usually associated with both amateur and commercial two-way frequencies. These systems make use of a special sub-audible tone that accompanies a transmitted signal.

CTCSS and DCS are used for many purposes. In many cases, CTCSS and DCS are used to restrict access to a commercial repeater, so that only those units which transmit the correct tone along with their signal can "talk" to the repeater.

CTCSS and DCS are also used in areas that receive interference where there are several stations with output frequencies close to each other. When this occurs, you might hear multiple communications on the same frequency. The stations might even interfere with each other to the point where it is impossible to clearly receive any of the stations. A scanner, such as your UBCD996T, equipped with CTCSS and DCS, can code each received frequency with a specific sub-audible CTCSS or DCS frequency or code. Then, when you receive multiple signals, you only hear the transmission with the CTCSS or DCS tone you programmed. If you do not receive the correct tone with a signal, the scanner's squelch remains closed and you hear nothing.

The tables showing the available CTCSS frequencies and DCS codes are found in the Reference Section on Page 138 of this manual.





Conventional Scanning

Conventional scanning is a relatively simple concept. Each group of users in a conventional system is assigned a single frequency (for simplex systems) or two frequencies (for repeater systems). Any time one of them transmits, their transmission always goes out on the same frequency. Up until the late 1980s, this was the primary way that radio systems operated.

Even today, there are many 2-way radio users who operate using a conventional system:

- Aircraft
- Amateur radio
- UHF/PRS
- Broadcast AM/FM/TV stations
- Many business radio users

When you want to store a conventional system, all you need to know is the frequencies they operate on. When you are scanning a conventional system, the scanner stops very briefly on each channel to see if there is activity. If there isn't, the scanner quickly moves to the next channel. If there is, then the scanner pauses on the transmission until it is over.

Simplex Operation

Simplex systems use a single frequency for both transmit and receive. Most radios using this type of operation are limited to line-of-sight operation. This type of radio is frequently used at construction job sites, and with inexpensive consumer radios such as UHF/PRS radios. The range is typically 1-12 kms, depending upon the terrain and many other factors.





Repeater Operation

Repeater systems use two frequencies: one transmits from the radio to a central repeater; the other transmits from the repeater to other radios in the system. With a repeater-based system, the repeater is located on top of a tall building or on a radio tower that provides great visibility to the area of operation. When a user transmits (on an input frequency), the signal is picked up by the repeater and retransmitted (on an output frequency). The user's radios always listen for activity on the output frequency and transmit on the input frequency. Since the repeater is located very high, there is a very large line of sight.

Typical repeater systems provide coverage out to about a 40kms radius from the repeater location.

What is Trunk Tracking?

Your UBCD996T is designed to track the following types of trunking systems.

- Motorola Astro 25 (APCO 25) trunking systems.
- Motorola Type I, Type II, Type III hybrid, SMARTNET, and PRIVACYPLUS analog trunking systems, which are extensively used in 800 MHz communication systems.
- LTR trunking systems
- EDACS SCAT trunking systems
- EDACS trunking systems

When tracking these types of systems, you might want to remember that your scanner can track more than one trunking system at a time and scan conventional and trunked systems at the same time.

Conventional scanning is a simple concept. You enter a frequency used by someone you want to monitor into your scanner's memory. For example, the police in your area might transmit on 460.500 MHz, the fire department on 154.445 MHz, the highway department on 37.900 MHz, etc. So when your scanner stops on a frequency, you usually know who it is, and more importantly, you can stop on a channel and listen to an entire conversation. This type of scanning is easy and fun.

However, as the demand for public communications has increased, many public radio users do not have enough frequencies to meet their needs, creating a serious problem. Trunking radio systems help solve this problem.





Trunked Scanning

While conventional scanning worked great while there were only a few groups wanting to use the frequencies, with the advent of smaller, lower-cost radios more and more agencies and businesses wanted to take advantage of the utility of 2-way radio. As a result, the bands that were used most became full, so new users were not able to take advantage of the technology as quickly as they wanted.

Trunking solved this frequency shortage by allowing multiple groups to use the same set of frequencies in a very efficient way. While each type of trunking system operates a little differently (see the next few sections), they all work on the same basic premise: even in a system with a lot of users, only a few users are ever transmitting at any one time.

Instead of being assigned a frequency, as with conventional systems, each group is assigned a talk group ID. A central computer controls the frequency each group operates on. This frequency selection is made each time a user transmits. So, while on a conventional system queries, replies, and follow-ups are all on a single frequency, they could each be on completely different frequencies on a trunked system. This semi-random frequency assignment made monitoring such a system impossible prior to Uniden's invention of the TrunkTracker scanner.

Not only does your UBCD996T scan channels like a conventional scanner, it actually follows the users of a trunked radio system. Once you know and program a talk group's ID (TGID), you won't miss any of the action.

If you are a new scanner enthusiast, you might want to read the first part of this manual and use your scanner in conventional mode before you begin trunk tracking. Understanding scanning fundamentals and terminology will make trunk tracking much easier. If you are already an experienced scanner operator, you can review the programming worksheets and their associated pages in the Reference Section of this manual.





Types of Trunking Systems

Trunking systems divide a few frequencies among many different users, but the way that each system does this is slightly different. This section describes some of the technical data behind Motorola, EDACS, and LTR trunked radio systems.

Motorola Trunking

While there are different types of Motorola trunking systems, they all use the same basic trunking method. The system consists of one control channel (or as many as 4 per system but only one is active at any one time), plus one or more voice channels (typically 10, 20, or 28 total channels). When a user presses Push To Talk (PTT) to transmit, their radio first sends the person's talk group information to the control channel. The computer then assigns that talk group to a specific voice channel and transmits that data over the control channel. All radios in that talk group switch over





to the assigned voice channel and the user can begin speaking. This all typically takes place in about a second...the person transmitting hears a beep from their radio when the channel is assigned. Then it is OK to start talking.

The systems in use are:

Motorola Type I — the radios send the radio ID, the fleet and subfleet talk group ID to the control channel each time they transmit. To program a Type I system, you need to know the system's *fleet map*. The most common fleet maps are included in the Reference section in this manual. You can also find fleet map resources on the web such as at <http://www.radioreference.com>.

Motorola Type II — the radios only send the radio ID and radio channel code to the control channel. The central computer keeps a database of radio ID's and which talk group is assigned to which channel code for each radio, so with this system the user's radio sends only about $\frac{1}{3}$ the data as a Type I system with each transmission. Type II systems do not use Fleet-subfleet talk groups; instead they use a 5-digit ID for each talk group.

Type III Hybrid — these systems support a mix of both Type I and Type II users. Like Type I systems, you must know the system's fleet map to ensure proper tracking.





Motorola ASTRO 25 (APCO 25) — these radios are similar to Type II systems, but send only the radio ID and radio channel code to the control channel, transmitting voice in digital form.

EDACS Trunking

EDACS trunking works in much the same way as Motorola trunking with a couple of major differences. In an EDACS system, each frequency used by the system is assigned a Logical Channel Number (LCN) so that less data needs to be transmitted by the control channel. Talk groups are assigned in an Agency-Fleet-Subfleet (AFS) hierarchy. There is one variation of EDACS called SCAT that your UBCD996T can monitor.

Logical Channel Numbers — each frequency used by the system is assigned an LCN. This information is programmed into each user radio. When a user presses PTT, their radio sends their AFS information to the control channel. The computer then assigns that talk group to a channel and sends the LCN so that all other radios in that talk group will switch to the correct channel. To program an EDACS system in your scanner, you will need to know both the frequencies used by the system and the LCN for each frequency.

Agency-Fleet-Subfleet — talk group ID's for EDACS systems are assigned in a way that makes it easy to see at a glance the affiliation of the user. Each radio is assigned a 2-digit agency identifier from 00 — 15. For example, 01 might be used by the police, 02 by the ambulance service, 03 by the fire department, and so on. Each



agency is then subdivided up to 16 times to provide fleet identification, and then 8 more times to identify subfleets.

For example, the complete AFS for the Police Department West District's dispatch channel might be 01-062. 01 identifies the agency as the police department, 06 identifies the fleet as the West district, and 2 identifies the subfleet as the dispatch channel. While these assignments are somewhat arbitrary and vary from system to system, there are many resources on the web for finding the assignments for most systems. Because of the logical hierarchy of the AFS system, your UBCD996T lets you assign wildcard ID's that let you, for example, use only one ID memory to identify all units in either an agency or a fleet.

EDACS SCAT — (Single Channel Autonomous Trunking) systems operate on a single channel and alternate control data with analog voice traffic. While your UBCD996T cannot track ID's in this system, it can eliminate the control data so that all you hear is the voice transmissions when you monitor this type of system.

LTR Trunking

LTR (Logic Trunked Radio) systems are trunking systems used primarily by business or private communications service providers, such as taxicabs, delivery trucks, and repair services. These systems encode all control information as digital sub audible data that accompanies each transmission, so there is no separate control channel. Users on an LTR system are assigned to specific talk groups, which are identified by the radio as six digit numbers.

These numbers are in the form AHHUUU, where:

- A = Area code (0 or 1)
- H = Home repeater (01 through 20)
- U = User ID (000 through 254)

When the scanner receives a transmission on a channel set to the LTR mode, it first decodes the LTR data included with the transmission. In the ID search mode, the scanner stops on the transmission and displays the talk group ID on the display. In the ID scan mode, the scanner only stops on the transmission if the LTR data matches a talk group ID that you have stored in the talk group ID list and have not locked out. LTR systems are frequently programmed so that each radio has a unique user ID.



Startup Configuration

Setup/Operation

The Startup Configuration option lets you quickly and automatically lock and unlock systems based on your desired configuration. Simply hold down a number button while powering on the scanner or while the opening screens are displayed. Systems assigned to that number are automatically unlocked and systems assigned to other numbers are automatically locked. Systems that are not assigned to any startup configuration are left unchanged.

You could use this feature to give you quick, single-press Quick Key access to your favorite systems even when you travel to other locations. For example, if you program your scanner as follows:

System/Site Quick Key	Configuration 1	Configuration 2
1	Fort Worth	Phoenix
2	Tarrant County	Mesa
3	Arlington	Mariposa Cnty

When you are in the Fort Worth area, press **[1]** while turning on the scanner. System Quick Keys **[1]**, **[2]**, and **[3]** then allow you to select between the local systems. When you travel to the Phoenix area, hold **[2]** while turning on the scanner. Now, the Fort Worth systems are locked out and System Quick Keys **[1]**, **[2]**, and **[3]** allow selection between the Phoenix-area systems.

Multi-Site Trunking

Some systems covering a very large geographic area use multiple antenna sites that each operate on different frequencies, but that use the same Talk Group ID's for traffic. When programming such a system, you program each site's frequencies and other settings into the system, then program the channels into channel groups within that system. Each site can have its own quick key, so you can turn each individual site on or off while you scan. Since all sites share all the channels within the system, multi-site trunking is much more efficient than programming each site as a separate system.





I-Call (Motorola/EDACS)

I-calls are direct unit-to-unit transmissions that are not heard by other system users. Your UBCD996T can receive I-call transmissions. See "Setting I-Call (Motorola and EDACS Systems Only)" on Page 72 for more information about monitoring I-call transmissions.

Where To Get More Information

By itself, this manual only provides part of what you need to know to have fun scanning — how to program and use the scanner. Other sources provide additional information.

Information On The Internet

The Internet is the best source for current frequencies and information about scanning. Many web sites are dedicated to providing lists of frequencies for your area. Many have built-in database search engines to assist you.

Make a list of the agencies you want to listen to, then look up the frequencies and systems used by those agencies. Here are a few useful sites:

- <http://www.radioreference.com> * — the Internet's premier source for user-supported radio system information.
- For Australia visit www.uniden.com.au, select any scanner product then click on "Scanner Frequency".
- For New Zealand visit www.uniden.co.nz, select any scanner product then click on "Scanner Frequency".

* - This web site is not affiliated with Uniden Australia Pty Ltd or Uniden NZ Ltd.

For more information about Uniden and our products, visit www.uniden.com.au (Australia) or www.uniden.co.nz (New Zealand).



Included With Your Scanner

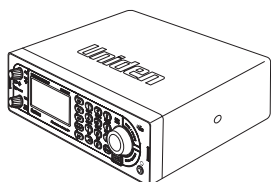

UBCD996T
Scanner

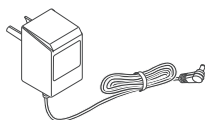

AC Adapter
(P/N AAD-996S)



Cigarette Lighter
Adapter Power Cord



Three Wire DC Power Cord

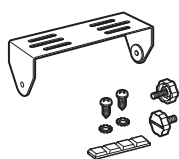

Mounting Bracket
and Hardware

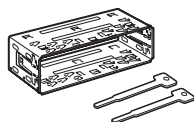

DIN-E Sleeve and
Removal Keys for
vehicle installation



Push-on type
Telescopic Antenna



Remote PC to Scanner
Cable (scanner plug to
Front PC Connector)



Owner's Manual and
other printed material

If any of these items are missing or damaged, immediately contact your place of purchase.

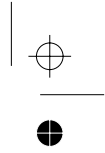
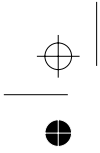

Setting Up Your Scanner

These guidelines will help you install and set up your new scanner:

The UBCD996T can be placed on a convenient surface in your home as a base station, and connected to a standard outlet that supplies 240VAC, 50Hz. You must use either the supplied antenna or an electrically correct outdoor antenna, properly and safely mounted at your chosen site.

The scanner is also designed to accommodate the DIN-E and ISO-DIN automotive mounting configurations. A DIN-E sleeve is supplied.

The unit can also be placed above or beneath the dash of your vehicle using the supplied bracket and mounting hardware.

- If your scanner receives interference or electrical noise, move the scanner or its antenna away from the source.
- To improve the scanner's reception, use an optional external antenna designed for multi-band coverage. (You can purchase this type of antenna at a local electronics store). If the optional antenna has no cable, use 50-75 Ω coaxial cable for lead-in. A mating plug might be necessary for the optional antennas.
- Use an optional mono earphone or mono headset with proper impedance (32 Ω) for private listening. Read the precautions on the inside front cover of this Owners Manual.
- Do not use the scanner in high-moisture environments such as the kitchen or bathroom.
- Avoid placing the scanner in direct sunlight or near heating elements or vents.

Base Station

This is the simplest approach to let you get started quickly. Decide on a location that is convenient to a nearby wall outlet, has desk space to let you complete your programming worksheets, will safely allow the indoor antenna to be extended, or near a window to use an outdoor antenna.

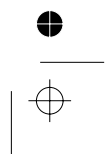
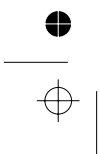

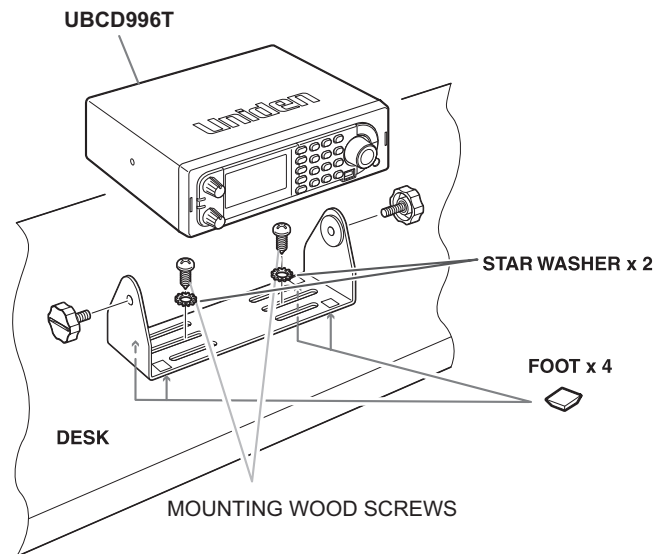

To secure the radio, by means of the mounting bracket, to a surface, follow the steps below:

1. Attach the four protective rubber feet to the mounting bracket when you casually use the scanner on a flat surface. Should you desire to permanently mount the scanner, remove the feet and use wood screws through the bracket as described in Steps 2 and 3.
2. Use the bracket as a template to mark positions for the two mounting screws.
3. At the marked positions, drill holes slightly smaller than the screws.
4. Align the bracket with the threaded holes on the sides of the radio case so the bracket is beneath the radio. Secure the bracket using the two threaded knobs. Never overtighten the knobs.

Once the radio is positioned, connect it to a source of AC power using the supplied **13.8V, 700 mA** AC adapter. Insert the barrel of the AC adapter to the jack on the rear, upper right side of the radio marked $\text{DC } 13.8\text{V}$ $\oplus \ominus$.



WARNING!

Use only the Uniden-supplied AC adapter with this scanner.

Insert the connector of the supplied indoor telescoping antenna to the **BNC Antenna Connector** and apply moderate pressure to secure it.

Setting Up an Audio Recording Device or Computer Recording

It is best if you plan ahead when you initiate the basic setup of the scanner if you include the components to record incoming reception. You need only an audio recording device which can be control by a Voice Operated module (VOX) either externally or from within the unit and the correct connecting cable.

The **REC** jack on the rear apron provides a constant-level audio output which is not affected by the setting of the volume control. Use a mono or stereo cable that ends in a 3.5mm plug for the scanner. The recorder might have its own requirements as to the proper plug Check the recorder's instructions to be sure.

Connect the cable to an external or internal VOX control so that the recorder activates when audio is present.

You can also connect the cable to the appropriate input jack on your PC so that with controlling software, you can record to your hard disc.

In order for the function to operate, you must set the channel to record. You must also set the system's record option to either **All Channel**, which will record all channels regardless of any channel's setting, or **Marked Channel** which only lets recording occur if you have selected record for that channel. Which you choose will depend on various factors.

Vehicle Installation

You can mount your scanner in your vehicle, using either the supplied bracket or the supplied DIN-E sleeve.

Mounting Using the Bracket

With the bracket removed from the radio, use the holes in the bracket as a template to initially mark the location you plan to use in your vehicle. Be absolutely certain of what might be behind the mounting surface before making any holes, be it above, or below, or in front of your dash, armrest console, or other location. If you drill carelessly, expensive damage can result. If in doubt, consult your vehicle dealer's service department or a qualified professional installer.



Important: AVOID AIRBAG DEPLOYMENT ZONES. Ignoring this installation concern may result in bodily harm and the inability of the airbag to perform properly.

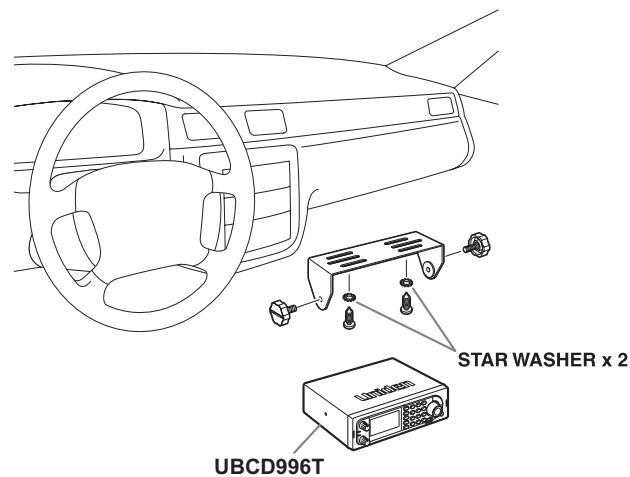

1. Using appropriate screws or other hardware, secure the bracket.
2. Insert the scanner and insert the bracket knobs to lock the scanner in position.
3. Attach the Cigarette Lighter Power Cord to the rear of the scanner and plug the adapter end into a dash mounted 12V DC socket.
4. Attach a suitable mounted mobile antenna to the antenna jack on the back of the scanner.

Mounting Using the DIN-E Sleeve

If you are unsure about how to install your scanner in your vehicle using the DIN-E sleeve, consult your automobile manufacturer, dealer, or a qualified installer. Before installing, confirm that your scanner fits in the desired mounting area and you have all the necessary materials to complete the task. Your scanner requires a 2-1/8 x 7-1/5 x 5-5/16 inch (53 x 183 x 135 mm) mounting area. Allow an additional 2-3/8 inch (60 mm) space behind the unit for connectors and wires.



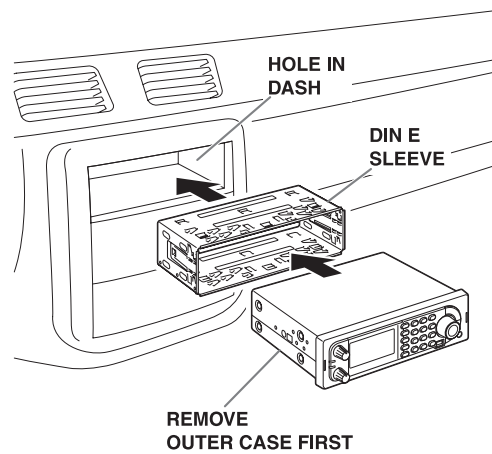

1. Remove the bracket if previously attached.
2. Remove the four Philips screws on the rear that secure the outer metal case and pull off the case with care.
3. Install the DIN sleeve into the opening in your dashboard, lip facing out.
4. Push out the top and bottom tabs to hold the sleeve firmly in place.
5. Before inserting the scanner in the sleeve, attach the cable from the previously mounted antenna. Attach the DC Power leads. RED goes to a positive (+) connection on your fuse block while BLACK connects to the vehicles chassis ground (-).
6. Connect the ORANGE lead to one side of the headlamp switch so that when you activate the headlights, the scanners LCD backlight dimmer level changes color and intensity. Be sure all the connections are routed away from any potentially pinching or slicing sheet metal.
7. Slowly slide the scanner into the sleeve until it locks in place.
8. To remove the unit, see " Removing the Scanner from the DIN-E Sleeve" on Page36" .

Note: if you plan to connect a GPS unit or external speaker at a later time, expect to remove the unit for ease of making those connections.

Removing the Scanner from the DIN-E Sleeve

If you plan to connect other devices or wires to the radio, such as a GPS unit, at a later time, you should plan to remove the scanner from the DIN-E sleeve. This is easily done using the provided Removal Keys. Refer to the illustration that shows the removal key(s), on Page 30 .

Fully insert both Removal Keys straight into the slots on the left and the right edges of the radio's dress panel. You cannot remove the radio if only one key is available. Press in fully and the radio will unlock from the sleeve making withdrawal from the sleeve possible. Store the keys in a safe place for future use.

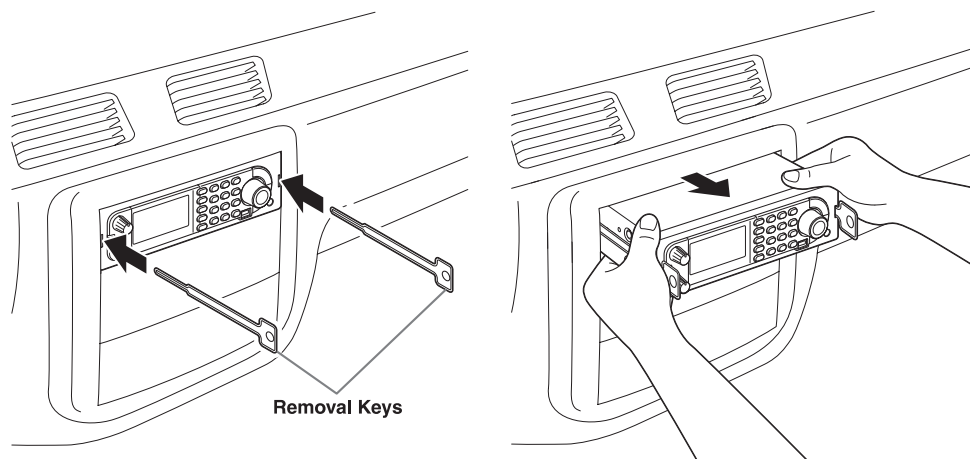

Mounting Using ISO Technique

Some vehicles can take advantage of another approach to mounting a radio in a vehicle, called the ISO technique. However, this technique requires a very detailed and thorough knowledge of the technique. Therefore, we strongly suggest that if you have any doubt about your experience and abilities, please consult with a professional installer who is familiar with the ISO approach to radio installation.

To begin the process, it is first necessary to remove the scanner's outer metal sleeve from the inner chassis. Unthread the four screws in the rear of the unit. Slide the cover toward the rear and off. Once the sleeve is removed, you will see threaded, metric machine screw holes on either side of the chassis cabinet. Uniden does not supply these screws. Their diameter, length, and screw type should be chosen by a qualified installer based on the internal vehicle bracket which will be used in securing the scanner chassis.

Once the original radio is removed from the vehicle dash and the fit of the scanner is correct, be sure to connect all the power, audio, antenna, and any other cables or wires, to the scanner before the scanner is secured. The following illustration is a typical example of the ISO technique and the general side mounting screw holes often encountered. It does not actually represent your vehicle or your vehicle's mounting bracket. Only a professional installer will be able to determine the best and correct approach.

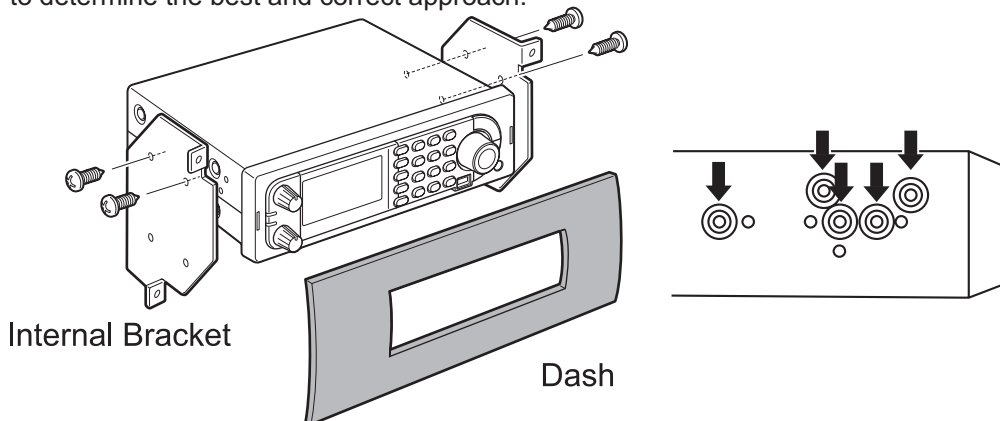

Removing the Display Sticker

Before you use the scanner for the first time, remove the protective plastic film over the display.

Connecting an Optional Antenna

The scanner's BNC connector makes it easy to connect a variety of optional antennas, including an external mobile antenna or outdoor base station antenna.

Note: Always use 50- or 75-ohm, RG-58, or RG-8, BNC terminated coaxial cable to connect an outdoor antenna. If the antenna is over 50 feet from the scanner, use RG-8 low-loss dielectric coaxial cable. Cable loss increases with higher frequency.

Connecting an Earphone/Headphone

For private listening, you can plug a 1/8-inch (3.5 mm) mini-plug earphone or headphones (not supplied) into the headphone jack on the front of your scanner. This automatically disconnects the internal speaker. See "Earphone Warning" at the front of the manual for important information about using an earphone/headphone.



WARNING!

Never connect anything other than the recommended amplified extension speaker to the scanner's headphone jack. Damage to the scanner might occur.

Connecting an Extension Speaker

In a noisy area, an optional amplified extension speaker, positioned in the right place, might provide more comfortable listening. Plug the speaker cable's 1/8-inch (3.5-mm) mini-plug into your scanner's back-panel **Ext. Sp. Jack**.

WARNING!

Never connect any part of the headphone jack to the antenna jack or connect the radio to an installation where the antenna and audio connection are grounded. This might also damage the scanner.



Controls, Keys, and Functions

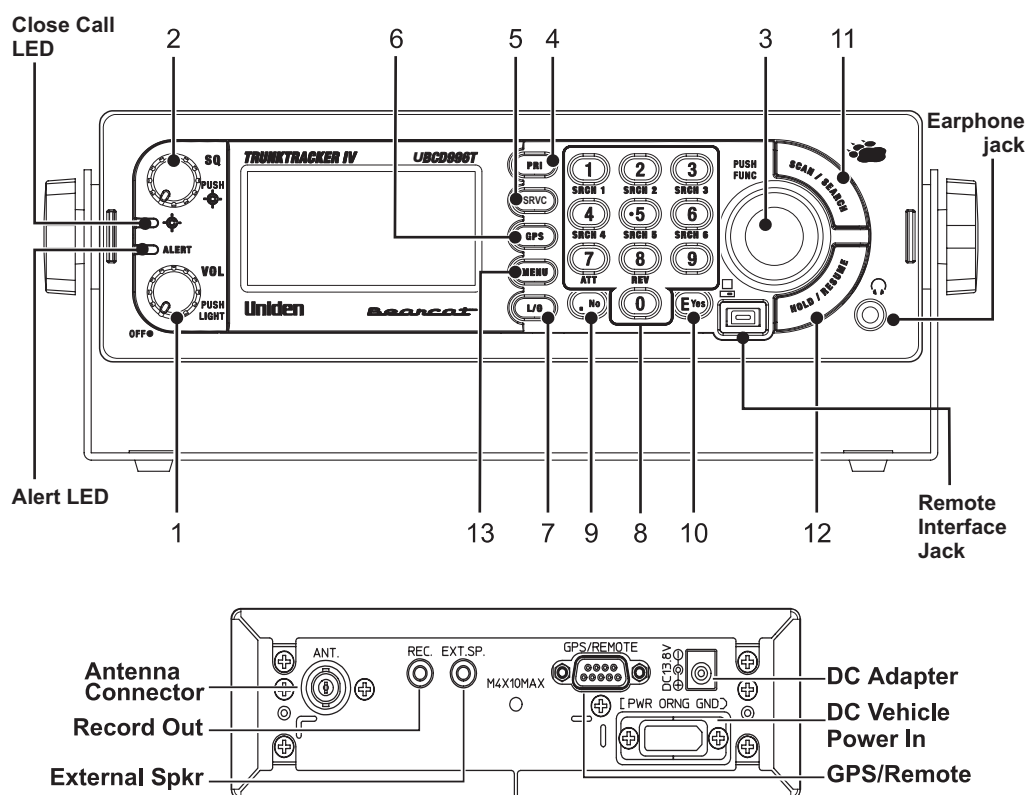

Each of the knobs and keys on the UBCD996T produce several different actions depending upon how you activate them. You can, for example, rotate the knobs as well as press them to achieve a different action. Some keys provide one action when briefly pressed while pressing and holding a key gives a different result. Finally, many controls and keys behave differently depending on the mode your radio is in when you use the key or control. Carefully examine the following table to separate those actions.

Note: “Press” means press and release briefly. “Press and hold” means press and hold down for at least 2-seconds. “**[Func]** + Press” means **Tap or Press the Scroll Control** to put the scanner into Function mode then press the key under discussion.

Control/Key	Label	Mode	Action	Result
[Power/VOL]	1	All	Rotate	Power ON — Volume Increase or decrease
		All	Press	Backlight enabled and intensity changes: Green Low-Green Medium-Green High-Red Low-Red Medium-Red High
		Function	Press FUNC then tap VOL Rotate Scroll Control	Sets APCO threshold
Squelch	2	All	Rotate	Sets the Squelch Level to permit strong signals to be heard with no background noise or lower strength signals with some background noise
			Press	Toggle: Close Call DND-CC Primary-OFF
			Press & Hold	Turns on Close Call Only Mode
			[Func] + Press	Toggles to Tone-Out stand by mode
Scroll Control and Function Button [Func]	3	All	Rotate	Turn to change scanning or searching direction.
		Scan or Custom Search	[Func] + Rotate	Turn to select System or Search Range
		Hold	Rotate	Turn to Select channel or frequency
		Menu	Rotate	Turn to scroll to menu item-Tap to select current option
			Press	Use as the <Enter> key for menu choices
		Name Edit	Rotate	Turn to select alpha/numeric entry for names
		Monitor	Rotate	Turn to resume scanning or searching
		GPS	[Func] + Rotate	Turn to operate alphabet skip
Function	Press/Tap	Switches to Function Mode; To latch Function Mode, press and hold [Func]		
[PRI]	4	Scan	Press	Toggle Priority Mode (On-Plus On-Off)

Control/Key	Label	Mode	Action	Result
[SRVC]	5	All	Press	Opens Service Search Select menu
[GPS]	6	All	Press	Changes to GPS Mode
		GPS	Press & Hold	Stores current GPS data
			[Func] + Press	Change GPS Display
[L/O]	7	Scan Search Hold	Press	Temporarily locks out a system channel, a search frequency, or location data. Cancelled when Power is turned off.
			Press 2X	Permanently locks out system channel, a search frequency, or location data. Remains locked after power cycle.
		Menu	Press	Exit the menu.
		Scan/ Scan Hold	Press & Hold	Enables System Quick Key and Group Quick Key in the current system. Unlocks System, Group and Channel in the current system.
			[Func] + Press & Hold	Turns off System Quick Key and Group Quick key in all systems. Unlocks system, group and channel in all systems.
		Search Search Hold Close Call Only Close Call Hold	Press & Hold	Unlocks all frequencies of Global Lockout List.

Control/Key	Label	Mode	Action	Result
[0] to [9]	8	Scan	Press	Enable/Disable selected System/Site Quick Keys
		Custom Search	Press	Turn on and off each custom search number
		All Hold Close Call Tone-Out	Press	Directly enter frequencies or Talk Group IDs
		Scan	[Func] + Press	Enable/Disable Group Quick Key
		Other than Scan or GPS	[Func] + Press [1] to [6]	[1] to [6] to start check of set search range
		Other than Scan or GPS	[Func] + Press [7]	[7/ATT] to toggle attenuator setting
		All	[Func] + [0]	Switches to Display Mode- Mode 1 default
		Scan/Scan Hold	[Func] + [.No]	Enables Trunking activity Indicators
[4] move left [6] move right		Editing Name	Press	Moves the cursor left or right during name or label editing.
[.No]	9	All	Press	Cancel error or warning messages
		Hold Close Call Only Tone-Out	Press	Enter "." For frequency
			Press	Enter "-" or "I" for TGID
			Press 2X	Delete current character in name edit
			Press 3X	Clear all letters in name edit
			Press	Enter "-" or "I" for Direct Entry
		Scan Scan Hold	[Func] + Press	Toggle Active Channel Display On or Off
Scan	Press	Starts two-digit of (SQK) System/Site Quick Key		

Control/Key	Label	Mode	Action	Result
[EYES]	10	MENU	Press	Use as the <Enter> key for menu choices
		Scan Scan Hold	Press	Edit the channel data for active channel
		Search Search Hold Close Call Close Call Hold SRVC Scan SRVC Scan Hold	Press	Saves the active frequency
		Tone-Out Standby	Press	Switches to Tone Out edit Menu to change Tone Out Settings
[SCAN/SEARCH]	11	Scan Hold	Press	Start Scanning
		Other than Scan or Scan Hold or GPS	Press	Instant switch to Scan Mode
		Search Hold	[Func] + Press	Toggle to resume searching
		GPS	Press	Toggle to scanner LCD
		Trunking Scan	[Func] + Press	Toggle ID Search and ID Scan.
[HOLD/RESUME]	12	Scan Search Close Call Only WX Scan	Press	Toggles HOLD on or off; In Close Call mode, error tone sounds if no frequency is detected.
[MENU]	13	Scan Scan Hold GPS	[Func] + Press	Initiates edit menu for current system, current search range, or current location data
		Menu	Press	Back up one level in the menu.
		All	Press	Use with Scroll Control to select menu settings

A Look At The Display

The display has indicators that show the scanner's current operating status. The display information helps you understand how your scanner operates. The LCD screens shown here are only a few of many that you will see while in different modes. The ones we show here are more common and will assist you to get started.

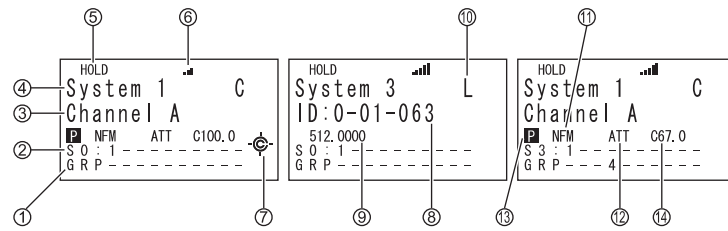

- | | |
|------------------------------|---|
| 1. Group Quick Key | 9. Talk group Frequency |
| 2. Site Quick Key | 10. System Type (M, C, E, L) |
| 3. Channel group Name | 11. Modulation Type (Narrowband FM shown) |
| 4. System Name | 12. Attenuation enabled |
| 5. Hold indicator | 13. Priority ON |
| 6. Signal Strength indicator | 14. CTCSS or DCS Indicator |
| 7. Close Call enabled | |
| 8. Talk group ID Number | |

Operation

Turning On the Scanner and Setting the Squelch

To turn the scanner on, rotate [VOL] clockwise. Turn the knob to a comfortable sound level.

Rotate the squelch control [SQ] clockwise until you either hear a broadcast or noise just stops. The control is now set for strong signals. If you desire to hear a weaker signal, turn it counter clockwise from that point until you hear background noise once more.

Startup Key Operation

You can setup a Startup Key Configuration so that the scanner can change the lockout for each system or each site by pressing an assigned key while you power up the scanner or an opening screen is displayed. Navigate to Set Startup Key there are differences in the menu structure for Trunked and Conventional systems.

Conventional

[MENU] → ↻ Program System →

Select the conventional system →

↻ Edit Sys Option →

↻ Set Startup Key → for each system.

Trunked

[MENU] → ↻ Program System →

Select the trunked system →

↻ Edit Site →

↻ Select the site →

↻ Set Startup Key → for each system or site.

Search Range

[MENU] → ↻ Search for... →





↻ Edit Service →

↻ Select a Service Range →

↻ Search with Scan →

↻ Set Startup Key →

OR



[MENU] → ↻ Search for... → ●
↻ Edit Custom → ●
↻ Select a Custom Range → ●
↻ Search with Scan → ●
↻ Set Startup Key → ●

Assign all the systems/sites that you want to scan at the same time. You can use one key [0] to [9] for each. In addition, you can assign the same startup key to the next system or site so that system or site is unlocked at power up. To change a Startup key back to unassigned, enter [.No].

Scanning Systems

To begin scanning preprogrammed or programmed systems, press [SCAN/SEARCH]. The UBCD996T scans all unlocked systems in all programmed and activated quick-key groups and any searches unlocked for search with scan.

To enable or disable systems or sites for scanning, press the site/system's System/Site Quick Key while scanning.

Notes:

- If no systems are programmed, or all systems are locked out, **Nothing to Scan** appears. Program a system or select a system to scan.
- When scanning multiple systems, the UBCD996T scans systems according to the assigned quick key. Systems assigned to quick key 1 is scanned first, then 2, 3, 4, etc. Systems not assigned to a quick key are scanned last, then unlocked searches. Within a quick key, systems are scanned in the order they were assigned.
- Within a system, channels are scanned according to the assigned channel group, with the same priority as described above for systems.
- The UBCD996T scans a system for the duration you set using the System Hold Time option (see "Setting the System Hold Time" on Page70). For trunked systems, the scanner moves to the next system after the hold time expires, the current transmission ends, and the channel delay expires. Conventional systems operate similarly, but all unlocked channels are scanned at least one time regardless of the hold time setting.
- Each search range is searched for the amount of time you set using the "Set Hold Time" option. See "Setting the System Hold Time" on Page70 for more information.



Selecting Systems to Scan

To select systems to scan, press **Scan** then press the quick key assigned to the system or systems you want to scan. For quick keys **[0] - [9]**, press the quick key's number. For quick keys 10-99, press **[.No]** then press the quick key's 2-digit number. To stop scanning the system(s), press **[.No]** (if the quick key is a 2-digit quick key) then the number button or buttons again.



The Sx: (system) indicators on the display show the systems that are currently selected.

To select or lock out a system that is not assigned to a key, press **[Func]** then rotate the Scroll Control until the desired system is selected. Then, press **[L/O]** within 2 seconds to either lock out or unlock the system.

Selecting System Channel Groups

Within a system, you can assign groups of channels to a group quick key (see “Setting the Group Quick Key” on Page84).

Follow these steps to activate or deactivate a channel group within a system while scanning.

1. Press **[HOLD/RESUME]** to hold on the system or tap  then turn the **Scroll Control**  to select the system.
2. While  still appears on the display, press the number key corresponding to the channel group you want to activate or deactivate.





Locking/Unlocking Systems



Follow these steps to lock out a system so that it does not scan even if its quick key is selected.

1. Tap the Scroll Control to switch to the Function Mode **Func** then rotate the control to select the desired system.
2. Press **[L/O]** to temporarily lock out the system. **Temporary L/O** appears. Or, quickly press **[L/O]** twice to permanently lockout the system. **Locked Out** appears.
3. To unlock temporarily locked out systems, turn power off and then back on. To unlock permanently locked out systems, repeat Steps 1 and 2. **System Unlocked** appears.

Locking/Unlocking Channels

If the scanner has stopped on a channel press **[L/O]** once to temporarily lock it out or quickly press **[L/O]** twice to permanently lock it out. Cycling power off/on automatically unlocks temporarily locked-out channels.

To lockout a channel when the scanner has not stopped on the channel, or to unlock a permanently locked-out channel.

1. Press **[HOLD/RESUME]** to hold on a channel.
2. Tap the **Scroll Control** to switch to the Function Mode **Func**, then rotate the control  to select the system where the channel is stored.
3. Tap the **Scroll Control** or wait 2 seconds, then rotate the **Scroll Control**  to select the channel you want to lock or unlock.
4. Press **[L/O]** to temporarily lock or unlock the current the channel. Double-tap L/O to permanently lockout the current channel.

ID Scan/ID Search Mode

While you are scanning a trunked system, the scanner can be in either ID Scan or ID Search mode:

- ID Scan — the scanner only stops on talk group ID's (TGID) that you have programmed into the system that are unlocked.









- ID Search — the scanner stops on any unlocked talk group that becomes active.

To toggle between ID Scan and ID Search, press  then press **[SCAN/SEARCH]** while the scanner is scanning the system.

If the scanner does not scan the system long enough for you to easily do this, press  and rotate the Scroll Control to select the changed system. Then, press **[SCAN/SEARCH]** within 2 seconds.

Holding On a System

To temporarily hold on a system, tap the **Scroll Control** . To hold on a different system, tap the **Scroll Control**  then rotate the control to select the system. Normal scanning resumes 2 seconds after your last selection.

To permanently hold on a site or system, press and hold the **Scroll Control** for 2 seconds.  flashes in the display's upper left corner. The scanner continues to scan only the current system. To hold on a different site or system, rotate the **Scroll Control**  to select the new site or system then press **[EYES]**.

Holding On a Channel

To hold on a channel, press **[HOLD/RESUME]** while the channel is active. To select a different channel, turn the **Scroll Control**. If you scroll past the beginning or end of the current system, the scanner selects channels in the previous or next system. To resume scanning, press **[SCAN/SEARCH]**.

Quickly Storing an ID During ID Search

To quickly store an active talk group ID during ID search, press **[EYES]**. You see: **Quick TGID Save?**

To save the ID into a channel, press **[EYES]**. Otherwise, press **[.No]**. If you press **[EYES]**, the scanner stores the ID into a channel group called **Qck Save Grp** in the current system.

Quick-Storing Channels or Talk Group ID's (TGID)

1. Hold on an existing channel in any system.
2. Enter the frequency or talk group ID you want to store (press twice to enter hyphens in talk group ID's).
3. To quick-store the channel or talk group ID, press **[EYES]**. Otherwise, press **[.No]**.



If you enter a frequency then press **[EYES]**, the scanner stores it in the **Qck Save Grp** group in a system called **Qck Save Cnv Sys**. These groups are created if they do not exist. Then, the scanner prompts you to save other channel settings.

If you enter a talk group ID then press **[EYES]**, the scanner stores it into a channel group named **Qck Save Grp** in the current system. If the talk group ID's format is not the type used by the current system, the scanner displays an error message and does not save the talk group ID.

If you pressed **[.No]** in Step 3, the scanner prompts you to select the system and the group where you want to store the frequency or talk group ID.

Note: The scanner will warn you if you try to store two channels in the same system that have the same frequency or Talk Group ID or if you try to store two systems with the same name.

Trunking Activity Indicators

To get a visual indication of the activity on trunking systems, press **[HOLD/RESUME]** to hold on any channel. Then tap the **Scroll Control** and then press **[.No]**. The scanner replaces the third line on the display with trunking activity indicators. When the scanner is monitoring on EDACS or Motorola system, the activity indicators will show which system frequencies have activity.

Note: for Motorola systems you must program all system frequencies (control and voice frequencies) for this feature to work.

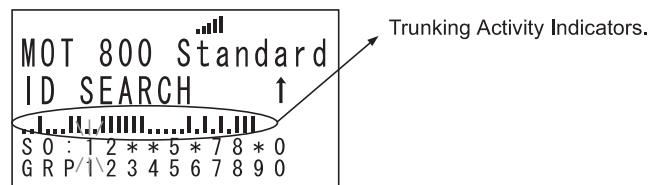

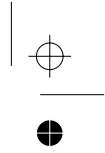
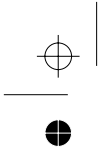

Toggling the Display Mode

To change the display so the channel and frequency or Talk Group ID appear instead of extended channel information, hold on any channel then press **[Func] + [0]**. The scanner displays **Display Mode 2**. To return to Mode 1, press **[Func] + [0]**

Mode1 indicates the **channel data** under the Channel Name.

Mode2 indicates the **frequencies** under the Channel Name.

```
  HOLD  . . .
System 1  C
Channel A
P NFM  ATT  C100.0  -C-
S O : 1 - - - - -
G R P - - - - -
```

Channel Name Display Mode 1



```
  HOLD  . . .
System 1  C
Channel A
      162.4000  C100.0
S O : 1 - - - - -
G R P - - - - -
```

Channel Name Display Mode 2

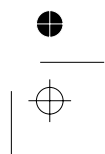
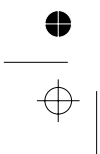

Optimizing P25 Performance

You can optimize the scanner's performance with digital APCO 25 systems. Follow these steps for each system where you can hear APCO 25 traffic.

Notes:

These steps work only when you can clearly receive the system. If you are in a weak-signal area or receive interference, these steps will not work. These steps do not compensate for weak signals or signals subject to interference.

If you set an incorrect decode threshold level in Step 5, the scanner might stop decoding all digital signals in the system. If this happens, change the setting to a value between 8 and 12 then repeat these steps.

Conventional System

[MENU] → Program System →

↻ Select the system →

↻ Edit Sys Option →

↻ Adjust P25 Level

Trunked System

[MENU] → Program System →

↻ Select the system →

↻ Edit Site →

↻ Select the site →

↻ Adjust P25 Level

Make sure the system's P25 Level option is set to **Auto**.

Press [HOLD/RESUME] on an active digital channel on the system. **HOLD** appears on the display.

Press [Func] then [VOL]. **F** disappears and **APCO Threshold Adjust Mode** appears at the bottom of the display.

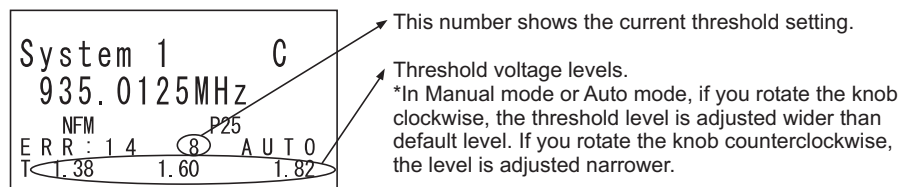

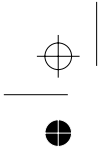

- The next to last line on the display now shows the digital error rate and the AUTO decode threshold start level (0-20).
- The last line on the display shows the decode threshold levels for the system.

Allow the scanner to monitor channel activity for several minutes. The error rate should drop for each transmission and the threshold levels should automatically adjust to a more optimal setting. Then, once the threshold level settles to a stable setting, write down these values. This is the system's optimum decode threshold.

Rotate the Scroll Control  to set the AUTO decode threshold start level to a setting that most closely matches the system's optimum decode threshold. Now, when the scanner stops on a system, it will use this threshold as the starting point for automatic optimization.

To exit when the settings are complete, press  then press **[VOL]**.

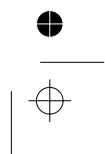
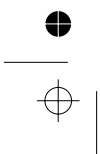
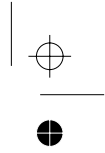

Using the Menu

The UBCD996T incorporates an effective menu system that lets you make all the necessary setting options required to program the scanner and effectively use the many features. To use the menu, press **[MENU]**.

You immediately see the screen display the menu title at the top and three of ten menu options beneath. Using the Multifunction Scroll Control, you can rotate the control left or right to quickly review all ten listings.

The depth of each menu selection is extensive. For the purpose of this manual, the following chart indicates the primary menu selection, the purpose of that selection, and a reference to the page or pages that provide the details associated with the option.

Menu Item	Let's You...	For Detail, See...
Program System	Select options related to setting up a new system or editing one already programmed.	See "Scanner Programming" reprint.
Program Location	Choose GPS related locations for data to alert, confirm location, and provide you with an audible warning if desired.	
Srch/CloCall Opt	Lets you adjust settings that affect the scanner during search and Close Call operation	See "Search and Close Call Options" on Page 104
Search for...	Choose and search programmed ranges of desired services	See "Searching and Storing" on Page 92
Close Call	Setup the radio to receive, and let you hear, nearby strong stations.	See "Using the Close Call Feature" on Page 100
Set Priority	Lets you scan a conventional system and check for designated priority channels.	See "Priority Scan" on Page 110
Tone-Out for...	Select up to 10 Tone-Out settings or Standby	See "Fire Tone-Out" on Page 114
Wired Clone	Copy data directly from one BCD996T to another BCD996T.	See "Wired Cloning" on Page 60
Settings	Choose settings for miscellaneous but convenient options.	See the respective pages for each option:



Programming General Settings



This section covers your scanner's general settings.

Setting and Using the Backlight

The LCD has a backlight that can be set to green or red with three levels of intensity for each color plus **OFF**.

To make your selection, press **[VOL]**. Each time you press the control, the backlight cycles in the following order.

OFF — Low Intensity Green — Medium Intensity Green — High Intensity Green — Low Intensity Red — Medium Intensity Red — High Intensity Red

When you stop at the desired level, the scanner remembers your setting the next time you turn on the scanner.

You can also set the backlight using the menu.

Setting the Dimmer

If you connect the orange wire to a wire in your car that changes state when you turn on the headlights, the scanner can automatically dim the display when you turn on the headlights. If you have not connected the orange wire, set Dimmer to Manual and manually select the dimmer level. If you have connected the orange wire, set Dimmer to Auto, then select "+ Polarity" if the orange wire gets 12V when you turn on the headlights or to "- Polarity" if the orange wire is switched to chassis ground when you turn on the headlights.

Tapping **[VOL]** overrides the menu setting and cycles through all backlight settings.

[MENU] →  Settings → 

 Set Backlight → 

 Set Dimmer → 

Auto — Use this setting if you have connected the scanner to your vehicle's headlights using the orange wire. If you select this option, the scanner automatically dims the backlight when you turn on the headlights. After selecting this option, select:

+ Polarity — If the headlight wire is connected to +12V when the headlights are on pick this setting.



- **Polarity** — If the headlight wire is connected to vehicle ground when the headlights are on, pick this setting.

Manual — Use this setting to manually set the dimmer level to **High**, **Middle**, **Low**, or **Off**. To guide you in your selection, at each setting the display shows what you can expect to see.

Setting the Backlight Color

[MENU] → ⤷ Settings →

⤷ Set Backlight →

⤷ Set Color →

Set this option to either Red or Green.

Adjusting the Key Beep

[MENU] → ⤷ Settings →

⤷ Adjust Key Beep →

Auto — the scanner automatically sets the key beep to match the master volume setting level you select.

Level 1 - 15 — the scanner lets you manually select one of fifteen key beep levels. As you turn the **Scroll Control**, the beep gets louder. Press  when you reach the desired level.

Off — the scanner turns the key beep off.

Setting the Audio AGC

[MENU] → ⤷ Settings →

⤷ Set Audio AGC →

This setting helps balance the audio level you hear as you listen to different radio sources so you can hear them at a similar volume. Use this setting if you listen to an audio source that has natural changes in audio level for which you want to compensate.

You can set the Analog or the Digital mode to be on or off.

Analog ⤷ to select either on or off specifically for receiving analog channels.

On — Press to select.

Off — Press to select.





Digital to select either **On** or **Off** specifically for receiving digital channels.

On — Press to select.

Off — Press to select.

Setting the Display Orientation

[MENU] → Settings →

Set Upside-down →

This setting controls the orientation of the display. If you set Upside-down to **On**, the scanner inverts the display text and graphics.

Adjusting the Display Contrast

There are 15 contrast levels. As you scroll from level 1 to 15 you see the contrast change. Press the **Scroll Control** to lock the desired level until the time you desire to change it.

[MENU] → Settings →

Adjust Contrast →

Select a level Level 1 to Level 15 →

Setting the GPS Format

[MENU] → Settings →

Set GPS Format →

These settings control how the scanner handles GPS input when you are using the location-based functions.

Setting the Position Format

[MENU] → Settings →

Set GPS Format →

Set Pos Format →

This setting controls the format used for entering GPS coordinates into the scanner.

DMS: DDD°MM'SS.ss — Enter the location in Degree, Minute, Second format.

DEG: DDD.dddddd — Enter the location in Degree and fraction format.





Setting the Time Format

[MENU] → ⤷ Settings →

⤷ Set GPS Format →

⤷ Set Time Format →

This setting controls the format used for displaying the time on the GPS data screens.

12H — the scanner displays time in 12-hour format using am for mornings and pm for evening times.

24H — the scanner displays time in 24-hour format using 0 for midnight and 23 for 11 pm.

Setting the Time Zone

[MENU] → ⤷ Settings →

⤷ Set GPS Format →

⤷ Set Time Zone →

This setting controls the format used for adjusting Universal time to local time. Set your local time's offset from UTC (formally known as GMT).

Setting the Distance Units

[MENU] → ⤷ Settings →

⤷ Set GPS Format →

⤷ Set Unit →

This setting controls the distance units shown in the GPS data screens and used for entering distance for POI's

mile — The scanner uses miles.

km — The scanner uses kilometers.

Setting the Serial Port Speed





[MENU] → ⤷ Settings →

⤷ Set Serial Port →

⤷ Set Baud Rate →

⤷ Set Front Port or Set Rear Port →

Use this setting to control the data rate used for the front and back panel serial ports. You typically set the front port to match the speed used to communicate with





your PC (default 115000 bps) and the back port to the speed used to communicate with an attached GPS (default 4800 bps). Note that the back port is male. You may need a gender changer and a null modem adapter to use a typical DB9 serial cable from the rear port.

For Serial Port Speed (Baud Rate), you may select from

4800 bps
9600 bps
19200 bps
38400 bps
57600 bps
115200 bps
OFF



Displaying Scanner Information

Viewing Memory Used

[MENU] → ⤷ Settings → 
⤷ See Scanner Info → 
⤷ % Memory Used → 

The scanner displays the percent of memory that is used and the number and the percent of systems, sites and channels that are created.
Press any key to return to the previous menu, then press any key to exit the menu.

Viewing the Firmware Version and Electronic Serial Number

[MENU] → ⤷ Settings → 
⤷ See Scanner Info → 
⤷ Firmware Version → 

Press any key to return to the previous menu, then press any key.

Initializing the Scanner's Memory

Warning: This clears data **you** have entered. You cannot restore user programmed data that has been deleted. You can, at a last step, restore only the original factory data.

1. To initialize the scanner's memory, turn off the scanner.

2. While pressing **[2]**, **[9]**, and **[HOLD]** at the same time, turn on power.

At that point anything you have programmed is gone.

You are given a last opportunity to keep the factory programmed data when you see the question:

Restore Preprogram List? Yes="E"/"No= ".

If you do not say Yes, the scanner is totally empty.

Connecting Your Scanner to a Personal Computer

You can connect your scanner, by means of the supplied cable, to a personal computer to download data from the computer to the memory of the scanner. Before you proceed, you must first set the scanner's communications speed as described in the previous section. In addition you will need a copy of Uniden Advanced Scanner Director software. You can download the software from www.uniden.com.au in the Customer Service Downloads link.

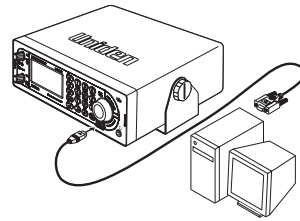

Important: Start with a high baud rate setting. If, during transfer, you get an error message, reduce the setting and start again until you get reliable, complete transfer of data.

Volume/Squelch with PC Control

If you use a PC to control the scanner, and you change the scanner's volume or squelch setting using the PC, the scanner ignores the front-panel control's current setting. However, if you later change the volume or squelch setting using the front-panel control, the scanner uses the control's setting (i.e. the scanner pays attention to the last method used).

Wired Cloning

Using the scanner in a cloning setup lets you transfer programmed data directly from a *source* or **master** UBCD996T to a *target* or **slave** UBCD996T. Wired cloning between other models to the UBCD996T is not possible.

[MENU] → **Wired Clone** **Master** or **Slave** (select one as the master and one as the slave)

To clone (transfer) data directly from one UBCD996T scanner to another UBCD996T scanner, you must first connect the scanners to each other using the included connection cables and a DB9 null modem adapter and for the rear port, a DB9 gender changer (neither included), available at most computer stores. Then you must set one scanner as the source and the other as the target.

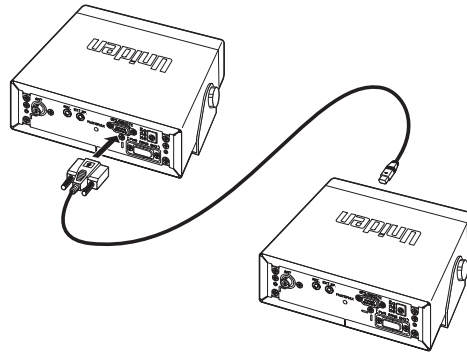

1. Select the Front Port for the Master. Select the Rear Port for the Slave or vice versa.
2. Plug the 9-pin serial connector into the unit designated as the Rear Port.
3. Plug the smaller connector into the front port of the unit designated as Front Port.
4. When you are ready to clone the scanner, press **Scan** on the slave scanner **first**, then **Scan** on the master scanner. The master scanner checks the connection between the two scanners, then transfers its data to the slave scanner.
5. When the transfer is complete, **Complete** appears on both scanners. If the transfer did not work, **Error** appears on the master scanner. Readjust the baud rate to a lower setting and try again.

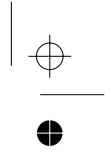
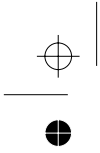

Programming Your Scanner

To get the most out of your UBCD996T you can organize frequencies into programmed radio systems.

To edit an existing system, use the menu to navigate to the system setting you want to change. This section assumes you are programming a new system. Programming radio systems is completed in two major steps. Don't skip either step!

1. Plan the system.
2. Program the system into your scanner according to the plan you prepared in Step 1.

General Notes

You can store up to 6000 channels in up to 500 systems. Each trunking system can have up to 256 sites and up to 250 trunked channels (TGID). Each conventional system can have up to 1000 channels.

Your scanner can have up to a total of 1000 sites. Each system can have up to 20 channel groups.

The following table provides you the information to successfully perform various steps connected with programming each of the systems: Conventional, Motorola, EDACS, and LTR. Some operations are common to all of the systems while some are specific to a given system. Use the following table to quickly locate the step you want or need to perform (where required), the reference page for that step, and to which system or systems it applies.

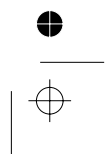
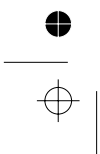

System Settings

System Settings	CNV	MOTOROLA		EDACS		LTR	See Pages
		TYPE I	P25 / TYPE II	Wide /Narrow	SCAT		
Edit Name	•	•	•	•	•	•	P. 67
Edit Sys Option	•	•	•	•	•	•	P. 68
Edit Site		•	•	•	•	•	P. 76
Edit Group	•	•	•	•		•	P. 83
Copy System	•	•	•	•	•	•	P. 76
Delete System	•	•	•	•	•	•	P. 76

System Options

System Option Settings	CNV	MOTOROLA		EDACS		LTR	See Pages
		TYPE I	P25/ TYPE II	WIDE/ NARROW	SCAT		
Set Quick Key	•						P. 68
Set Startup Key	•						P. 69
Set Lockout	•						P. 69
Set Hold Time	•						P. 70
ID Scan/Search		•	•	•		•	P. 70
Set Delay Time	•	•	•	•	•	•	P. 70
Set Data Skip	•						P. 70
Set LocationInfo	•						P. 71
Edit Fleet Map		•					P. 71
Set Status Bit		•	•				P. 72
Set End Code		•	•				P. 72

System Option Settings	CNV	MOTOROLA		EDACS		LTR	See Pages
		TYPE I	P25/ TYPE II	WIDE/ NARROW	SCAT		
Set I-Call		•	•	•			P. 72
Emergency Alert		•	•	•			P. 73
EDCS ID Format				•			P. 73
Set Record	•	•	•	•	•	•	P. 74
Rvw ID:Srch L/O		•	•	•		•	P. 74
Clr All L/O IDs		•	•	•		•	P. 74
Adjust P25 Level	•						P. 75

Site Settings

Site Setting	MOTOROLA TYPE I		MOTOROLA P25/TYPE II						EDACS			L T R
	800MHz Standard	800MHz Splinter	P25	800MHz Standard	800MHz Splinter	900MHz Band	VHF Band	UHF Band	WIDE	NARROW	SCAT	
Edit Name	•	•	•	•	•	•	•	•	•	•		
Set Quick Key	•	•	•	•	•	•	•	•	•	•	•	•
Set Startup Key	•	•	•	•	•	•	•	•	•	•	•	•
Set Frequencies	•	•	•	•	•	•	•	•	•	•	•	•
Set Modulation	•	•	•	•	•	•	•	•				•
Set Attenuator	•	•	•	•	•	•	•	•	•	•	•	•
Set Lockout	•	•	•	•	•	•	•	•	•	•	•	•
Set Hold Time	•	•	•	•	•	•	•	•	•	•	•	•
Edit Band Plan			•				•	•				
Set C-Ch Only	•	•		•	•	•	•	•				
Set LocationInfo	•	•	•	•	•	•	•	•	•	•	•	•
Adjust P25 Level	•	•	•	•	•	•	•	•	•	•		•
Delete Site	•	•	•	•	•	•	•	•	•	•		
New Site	•	•	•	•	•	•	•	•	•	•		

Channel Settings

Channel Setting	CNV	MOT TYPE I	MOT TYPE II/P25	EDACS	LTR
Edit Name	•	•	•	•	•
Edit Frequency	•				
Edit TGID		•	•	•	•
Set Audio Type	•	•	•	•	•
Set Modulation	•				
Set Attenuator	•				
Set Priority	•				
Set Alert	•	•	•	•	•
Set Record	•	•	•	•	•
Set Lockout	•	•	•	•	•
Copy Channel	•	•	•	•	•
Delete Channel	•	•	•	•	•
New Channel	•	•	•	•	•

Programming Conventional Systems

[MENU] → Program System →

New System →

Conventional →

Confirm? Yes="E" / No="."

The scanner creates an empty conventional system with a default name of **System n C**. Note that "n" is a number that increments as you add new systems. The C on the right side of the display indicates that this is a conventional system. After creating the system:

1. Set system-level settings that apply to conventional systems in "Programming System Settings."
2. Create one or more channel groups with channels as described in "Programming Channel Groups."



Programming Trunked Radio Systems



[MENU] → Program System → 

 New System → 

Then, select the system type:

MOT TYPE1 — Motorola Type I systems

MOT TYPE2/P25 — Motorola Type II and APCO 25 systems

EDCS WIDE/NARROW — EDACS Wide and Narrow systems

EDCS SCAT — EDACS SCAT systems

LT — LTR Systems

The scanner creates an empty system with a default name of **System n x**. Note that “n” is a number that increments as you add new systems. The “x” on the right side of the display is M for Motorola system, E for EDACS systems, and L for LTR systems. After creating the system:

1. Set the system-level settings in “Programming System Settings” that apply to the type of system you selected.
2. Set up at least one site for the system as described in “Programming Sites” on Page76.
3. To scan specific channels, create one or more channel groups with channels as described in “Programming Channel Groups.”

Programming System Settings

Editing the System Name

MECL

Each system name can be up to 16 characters. Abbreviate as necessary to fit. For Motorola and EDACS Wide/Narrow systems, the system name only appears in the scanner menu’s Program System listings. It is not shown during scanning. For other systems, the system name alternates with the Channel group when the scanner stops on a channel.

The default system names include the following letter in the 16th position to indicate the system type:

M = Motorola; **E** = EDACS; **L** = LTR; **C** = Conventional;

Throughout the balance of this manual you will see a designation such as **MELCS** on the same line as a heading. This means that the section, in this example, applies **Motorola, EDACS, LTR, Conventional and EDACS SCAT** systems.

Specifying the Correct System Type

In order for trunk tracking to work properly, you have to specify the correct system type when you create the system. Here are some tips for selecting the correct type:

Use online resources, such as the www.radioreference.com database, to identify the system type.

Even though a system has digital channels, it is not necessarily a P25 system. To be P25, the system type must be described as Project 25 (there are many Motorola 800 Standard systems that have some digital channels).

These should be entered as Motorola 800 Standard and not P25).
EDACS Wide is the same as EDAC Standard.

EDACS Networked sites are EDACS Narrow
Following these steps to change the system name.

[MENU] → **Program System** →

Select the system →

Edit Name →

To enter a letter, turn the **Scroll Control** until the character you want appears. To enter a decimal point, press **[.No]**. To move the cursor to the left, press **[4]**. To move the cursor to the right, press **[6]**.

To clear a character, press **[.No]** twice. To clear all characters, press **[.No]** 3 times. To accept an entry, press **[EYES]** or .

Programming System Options

MELCS

Editing the System Quick Key

C

[MENU] → **Program System** →

Select a conventional system →

Edit Sys Option →





Set Quick Key →

After selecting this option, select any number from 0-99 to assign the system to a quick key or press **[.No]** to assign the system to no quick key, then press .

Notes:

- Access single-digit system/site Quick Keys by pressing the single digit on the keypad during scanning. Access two-digit system Quick Keys by pressing **[.No]** then both digits.
- You can assign as many systems to the same quick key as you want.
- To be scanned, a system's Quick Key must be activated and the system must be unlocked.

Setting the Startup Key C





- [MENU] → Program System → 
- ↻ Select a conventional system → 
- ↻ Edit Sys Option → 
- ↻ Set Startup Key → 

Select a startup key from 0-9 or select “.” for no startup key.

Notes:

- To unlock the system at startup, press and hold the selected startup key while you apply power. If you do not press the startup key at the time you turn on power, you can still act while the opening screens are displayed.
- The system Quick Key is also enabled.
- If you press a different key at startup, the system is locked out.
- If you do not assign the system a startup key, the system is not affected by any key press during startup.

Setting the System Lockout C

- [MENU] → Program System → 
- ↻ Select a conventional system → 
- ↻ Edit Sys Option → 
- ↻ Set Lockout → 

Unlocked — The system is scanned when its quick key is enabled.

Temporary L/O — The system is not scanned, even if its quick key is enabled. Cycling power will remove the lockout.

Lockout — The system is not scanned, even if its quick key is enabled. You must manually unlock the system.

Setting the System Hold Time

C

- [MENU] → Program System →
- ↻ Select a conventional system →
- ↻ Edit Sys Option →
- ↻ Set Hold Time →

Set how long the scanner will remain scanning on this system before moving to the next system (up to 255 seconds). Note that the scanner will scan all unlocked channels at least one time, regardless of the system hold time setting.

Setting ID Scan/ID Search

MEL

- [MENU] → Program System →
- ↻ Select a system →
- ↻ Edit Sys Option →
- ↻ ID Scan/Search →

Sets whether the scanner only stops on talk groups you have programmed in (ID Scan) or whether the scanner stops on any unlocked channel (ID Search).

Setting Channel Delay Time

MELCS

- [MENU] → Program System →
- ↻ Select a system →
- ↻ Edit Sys Option →
- ↻ Set Delay Time →

This setting controls how many seconds the scanner waits after a transmission ends before resuming scanning. Enter a value from [1] to [5] or Off, then press .

Notes:

- The default setting is 2 seconds for each system.
This setting applies to all channels within the system.

Setting Data Skip

C

- [MENU] → Program System →
- ↻ Select a Conventional system →
- ↻ Edit Sys Option →
- ↻ Set Data Skip →

This setting controls whether the scanner automatically skips channels it identifies as data. This includes channels with either no audio or a constant-level audio source. If turned on, the scanner resumes scanning as soon as it detects the data signal.



Setting Location Information

C

[MENU] → Program System →

↻ Select a Conventional system →

↻ Edit Sys Option →

↻ Set LocationInfo →

This setting control whether the system is automatically enabled and disabled when you connect a GPS to the scanner.

Set Latitude — Enter the system's latitude using the format you selected in the system settings.

Set Longitude — Enter the system's longitude using the format you selected in the system settings.

Set Range — Set the system's range using the units you selected in the system settings.

Set GPS Enable — L/O status is automatically controlled by receiving data from GPS.

Setting the Fleet Map

M (Type I Only)

[MENU] → Program System →

↻ Select a Motorola Type I system →

↻ Edit Sys Option →

↻ Edit Fleet Map →

Preset — select from the 16 most common fleet maps

Custom — allows you to enter a custom fleet map. Enter the size code (0 to 14) for each block. Press to select.

For Motorola Type I systems, you must enter a system fleet map in order for the scanner to properly track and display talk group ID's. The fleet map is usually included in the same resource that provided system frequencies and talk group ID lists.

Note: If you don't know the fleet map for your Motorola Type I system, check the Internet such as www.radioreference.com or the other websites we reference.





Setting the Status Bit

M

[MENU] → Program System →

↻ Select a Motorola Type I or II system →

↻ Edit Sys Option →

↻ Set Status Bit →

Ignore — the scanner rounds all received ID's down to the next interval of 16. The default setting is **Ignore**.

Yes — the scanner treats all received ID's as unique ID's.

Note: Motorola analog systems use talk group ID's in multiples of 16. ID numbers that fall between these ID's indicate special status flags for the system. This setting determines how the scanner will handle ID's that are not multiples of 16. Select your setting then press .

Setting End Code Operation

M

[MENU] → Program System →

↻ Select a Motorola Type I or II system →

↻ Edit Sys Option →

↻ Set End Code →

This setting determines how the scanner handles the transmission end code sent by most Motorola systems. Select your setting then press .

Yes — the scanner immediately returns to the control channel when it detects the end code.

Ignore — the scanner does not return to the control channel until the carrier drops.

Note: The default setting is **Yes**.

Setting I-Call Operation

ME

[MENU] → Program System →

↻ Select a Motorola Type I, II or EDACS Wide/Narrow system →

↻ Edit Sys Option →

↻ Set I-Call →

This setting determines how your scanner treats I-calls while ID Searching.

On — the scanner tracks I-calls.





off — the scanner ignores I-calls. The default setting is **off**.

Only — the scanner only tracks I-calls and ignores other radio traffic on the system. Press to select.

Note: To set the I-Call to a wildcard receive condition, press **[.No] + [0]**.

Setting the Emergency Alert Option

ME

MENU] → **Program System** →

Select a Motorola Type I, II or EDACS Wide/Narrow system →

Edit Sys Option →

Emergency Alert →

off — the scanner does not alert you to emergency transmissions.

Alert 1 - 9 — the scanner sounds an alert beep to notify you of the emergency transmission. The default alert is **off**. You can choose any of 9 different beep types. Once you choose an alert tone, next:

Set Level →

Auto — the scanner automatically sets the emergency alert beep to the master volume level.

Level 1 - 15 — the scanner adjusts the volume you hear to the level you select.

Setting the EDACS ID Format

E

[MENU] → **Program System** →

Select an EDACS Wide/Narrow system

Edit Sys Option →

EDCS ID Format →

EDACS Talk Group ID's are commonly provided in one of two formats: **AFS** and **Decimal**. This setting determines how you enter EDACS ID's and how the scanner displays them.

AFS Format — the scanner uses AFS format for Talk Group ID's

Decimal Format — the scanner uses decimal format for Talk Group ID's

Note: The scanner defaults to AFS (agency, fleet, subfleet) format - the format used in most EDACS systems.





Setting the System Record Option

MELCS

[MENU] → Program System →

Select a system →

Edit Sys Option →

Set Record →

This setting controls how the scanner handles the record option for channels in the system.

All Channel — The scanner sends the audio for all channels in the system to the **REC** jack, regardless of the channel's record option setting.

Marked Channel — The scanner only sends the audio for channels that have the Record option turned on to the **REC** jack.

Off — The scanner does not send any audio from any channel in the system to the **REC** jack, even if the record option is turned on for a channel.

Note for systems: In order for the function to work, you must set the channel to record. You must also set the system's record option to either **All Channel** (which will record all channels regardless of the channel's record setting) or **Marked Channel** (which only records the channels you've set to record).

Reviewing ID Search Lockouts

MEL

[MENU] → Program System →

Select a trunked system →

Edit Sys Option →

Rvw ID:Srch L/O →

The scanner displays each locked out ID for the system and gives you the option to Unlock the ID. To unlock an ID, rotate the scroll to select the locked out ID, then press [EYES]. If no ID's are locked out, the scanner displays "Nothing Locked / Press Any Key."

Clearing All Locked Out ID's

MEL

[MENU] → Program System →

Select a trunked system →

Edit Sys Option →

Clr All L/O IDs →

To quickly unlock all IDs in the system, answer "Y" to "Confirm? Unlock All (Y/N)."





Adjust the P25 Decode Threshold

C

[MENU] → Program System →

↻ Select a conventional system →

↻ Edit Sys Option →

↻ Adjust P25 Level →

This setting determines some system-specific parameters for digital channels. In most cases, setting this to **Auto** provides the best performance. However, you can also manually set the digital decode threshold. This setting affects all channels in the current system. See “Optimizing P25 Performance” on Page52.

Auto — the scanner automatically adjusts the digital decode threshold to match the transmission you are hearing when it receives a strong signal and has a high decode rate.

Manual — lets you manually adjust the digital decode threshold. To manually adjust the P25 level, select **Manual**.

Default — sets the digital decode threshold to the default value. Use this setting to return to the value that usually provides adequate performance. This is handy as you have manually adjusted the value to a setting that prevents proper decoding.

Note: This setting has no effect on how these systems are received.

Editing Sites

MESL

Use this option to enter and edit site information for the current system. See “Programming Sites” on Page76 for instructions for each site option. Note that you must program at least one site for each trunked system in order for your scanner to scan the system.

Editing Channel Groups

MECL

Use this option to enter and edit channel groups and channel information. See “Programming Channel Groups” for instructions for each channel group and channel option. Note that you must program at least one channel group and one channel for each conventional system in your scanner. You do not have to enter channel group information for trunked systems, but doing so makes it easier to follow specific talk groups.





Copying Systems

MECSL

Occasionally you might want to copy and rename a system to highlight one group over another.

One system might be called City - Fire and the same system City - PD with adjustments to data within.

This lets you quickly locate the desired set of data.

To copy a system including all settings, groups, and channels:

[MENU] → Program System →

Select the existing system →

Copy System →

New Sys Name?

Enter your new name using the **Scroll Control** and [4] and [6] to traverse the display and enter characters. Press when finished.

Deleting Systems

MECSL

[MENU] → Program System →

Select the existing system →

Delete System →

Confirm Delete?

Yes="E" / No= ". "

Important: Deleted systems cannot be restored. You must re-enter them.

Programming Sites

MESL

This section covers settings that apply to trunked radio site. You must program at least one site for each trunked radio system. When you program multiple sites, all sites share the same channel groups and channels within the system.

Note: You can only program one site in an EDACS SCAT and LTR system.

Setting the Site Name

ME

Each site name can be up to 16 characters. Abbreviate as necessary to fit. The site name alternates with the Channel group when the scanner stops on a channel.

The default site names include the following letter in the 16th position to indicate the system type:



MS1: Motorola 800 MHz Type I Standard
MS2: Motorola 800 MHz Type II Standard
MP1: Motorola 800 MHz Type I Splinter
MP2: Motorola 800 MHz Type II Splinter
P25: APCO 25 (all bands)
M92: Motorola 900 MHz
MV2: Motorola VHF
MU2: Motorola UHF
EDW: EDACS Wide
EDN: EDACS Narrow

Follow these steps to change the system name.

[MENU] → Program System →

↻ Select a trunked system →

↻ Edit Site →

↻ Select a Site →

↻ Edit Name →

To enter a letter, turn the **Scroll Control** until the character you want appears. To enter a decimal point, press [.No]. To move the cursor to the left, press [4]. To move the cursor to the right, press [6].

To clear a character, press [.No] twice. To clear all characters, press [.No] 3 times. To accept an entry, press [EYES] or .

Setting the Site Quick Key

MESL

[MENU] → Program System →

↻ Select a trunked system →

↻ Edit Site →

↻ Select a Site →

↻ Set Quick Key →

After selecting this option, select any number from 0-99 to assign the system to a quick key or press [.No] to assign the system to no quick key, then press .



Notes:

- Access single-digit system/site Quick Keys by pressing the single digit on the keypad during scanning. Access two-digit system Quick Keys by pressing **[.No]** then both digits.
- You can assign as many systems to the same quick key as you want.
- To be scanned, a system's Quick Key must be activated and the system must be unlocked.

Setting the Site Startup Key

MESL

[MENU] → **Program System** →

Select a trunked system →

Edit Site →

Select a Site →

Set Startup Key →

Select a startup key from 0-9 or select "." for no startup key.

Notes:

- To unlock the system at startup, press and hold the selected startup key while you turn on the scanner.
- The system Quick Key is also enabled.
- If you press a different key at startup, the system is locked out.

If you do not assign the system a startup key, the system is not affected by any key press during startup.

Setting Site Frequencies

MESL

[MENU] → **Program System** →

Select a trunked system →

Edit Site →

Select the site →

Set Frequencies →

New Frequency (or select an existing frequency) → Input a site frequency using the number keys and **[.No]** key, then press . If you are entering frequencies for an LTR or EDACS system, the scanner will also prompt you to enter the LCN for the frequency you just entered. LCN's (logical channel numbers) are provided from the same source where you got the other system information.

To enter additional frequencies, press **[MENU]**, then to select **New Frequency**. Then repeat the above.





Note: If you select Control Channel Only mode (see “Setting Control-Channel Only (Motorola Systems Only)” on Page 81), you only need to enter the frequency(s) that can be assigned as the control channel. Most frequency lists usually indicate which of the frequencies are the control channel frequencies. Otherwise, you must enter all of the frequencies.

Setting Site Modulation

ML

[MENU] → Program System →

Select a trunked system →

Edit Site →

Select a Site →

Set Modulation →

Auto — the scanner uses the default modulation for the frequency band.

FM — the scanner uses FM (frequency modulation) for the frequency band.

NFM — the scanner uses narrowband FM for the frequency band.

Note: The default setting is **Auto**.

This setting controls the modulation method used for the frequency band. In most cases, if you leave this set to **Auto**, the scanner automatically selects the correct modulation type for the system you are programming.

Setting Site Attenuation

MESL

Enable Attenuation if you are near strong signal sources. Attenuation can help reduce interference and desensitization that strong signals create. You can also turn this setting on or off by holding on a trunked system, then pressing + [7].

[MENU] → Program System →

Select a trunked system →

Edit Site →

Select a Site →

Set Attenuator →

off — the attenuator is off.

on — site frequencies are attenuated by about 20 dB.

Setting Site Lockout

MESL

[MENU] → Program System →

Select a trunked system →





- ↻ **Edit Site** →
- ↻ Select a site
- ↻ **Set Lockout** →
- ↻ Select from the following choices

Unlocked — the system is scanned when its quick key is enabled.

Temporary L/O — the system is locked for this session.

Lockout — the system is not scanned.

Setting Site Hold Time

MESL

- [MENU] → **Program System** →
- ↻ Select a trunked system →
- ↻ **Edit Site** →
- ↻ Select a site →
- ↻ **Set Hold Time** →

This setting controls how many seconds the scanner looks at a site before moving to the next unlocked site or system. Using the number keypad, enter a value from 0-255, then press **↻** to save the setting.

Notes:

- If the scanner cannot detect a control channel on an EDACS or Motorola system, it immediately moves to the next site or system. The scanner always scans LTR or SCAT systems for at least 1 second to check for current activity.
- If you select 0 and the control channel is received, the scanner stays on the system for a minimal time (only long enough to check current system activity).
- The default setting is 2 seconds for each system.

The scanner moves to the next system after the hold time expires, any current transmission ends, and the channel delay time expires.

Editing the Band Plan

M (VHF and UHF only)

In order for the scanner to scan Motorola VHF and UHF sites, you must enter parameters that allow the scanner to determine the frequencies in use by the system. This information is normally available at the same source where the other system information is found.

- [MENU] → **Program System** →
- ↻ Select a Motorola Type II/P25 system →
- ↻ **Edit Site** →





- ↻ Select a VHF or UHF site →
- ↻ **Edit Band Plan** →

You can enter up to 3 band plans. Select the plan to enter or edit, then follow the prompts to enter the Base Frequency, Channel Step, and Channel Offset for the site.

Setting P25 Band Plans

(P25 Only)

The UBCD996T includes two operation modes for P25 systems: explicit mode and implicit mode channel assignment. Explicit mode systems include all information needed to determine voice frequencies on the control channel. You must supply the system's band plan for intrinsic systems for the scanner to correctly determine voice frequencies.

To set the band plan for a P25 system:

- [MENU] → **Program System** →
- ↻ Select a Motorola Type II/P25 system →
- ↻ **Edit Site** →
- ↻ Select a P25 site →
- ↻ **Edit Band Plan** →

Then, follow these steps:

- ↻ the Band Plan table entry you want to edit and → .
- Enter the base frequency for the table entry and → .
- Enter the spacing for the table entry (in kHz) and → .

Repeat 1-3 for additional table entries.

Notes:

- For Explicit mode systems, leave all entries blank. There is no way to determine the correct entries using the scanner (other than trial and error). You must get this information from another source. Uniden Australia Pty Ltd and Uniden NZ Ltd does not have this information.

Setting Control-Channel Only Mode

M (except for P25)

- [MENU] → **Program System** →
- ↻ Select a trunked system →
- ↻ **Edit Site (current)** →
- ↻ Select a non-P25 site →
- ↻ **Set C-Ch Only** →





On — You only need to enter control channel frequencies.

Off — You must enter all voice and control channel frequencies.

Note: The scanner defaults to **On**.

Setting Site Location Information

MESL

[MENU] → Program System →

↶ Select a trunked system →

↶ Edit Site (current) →

↶ Select a site →

↶ Set LocationInfo →

This setting control whether the system is automatically enabled and disabled when you connect a GPS to the scanner.

Set Latitude — Enter the system's latitude using the format you selected in the system settings.

Set Longitude — Enter the system's longitude using the format you selected in the system settings.

Set Range — Set the system's range using the units you selected in the system settings.

Set GPS Enable — Depending on the data received from the GPS, the L/O status of the site is automatically controlled.

Adjust P25 Level

MEL

[MENU] → Program System →

↶ Select a trunked system →

↶ Edit Site (current) →

↶ Select a site →

↶ Adjust P25 Level →

This setting determines some site-specific parameters for digital channels. In most cases, setting this to **Auto** provides the best performance. However, you can also manually set the digital decode threshold. This setting affects all channels in the current site. See "Optimizing P25 Performance" on Page52.





Auto — the scanner automatically adjusts the digital decode threshold to match the transmission you are hearing when it receives a strong signal and has a high decode rate.

Manual — lets you manually adjust the digital decode threshold. To manually adjust the P25 level, select **Manual**.

Default — sets the digital decode threshold to the default value. Use this setting to return to the value that usually provides adequate performance. This is handy if you have manually adjusted the value to a setting that prevents proper decoding.

Note: This setting has no effect on how these sites are received.

Deleting Sites

ME

[MENU] → Program System →
 ↻ Select a trunked system →
 ↻ Edit Site →
 ↻ Select a site →
 ↻ Delete Site →
 Confirm Delete?
 Yes="E" / No= "."

Important: Deleted sites cannot be restored. You must re-enter them.

Programming Channel Groups Setting Up a Channel Group

**MECL
MECL**

[MENU] → Program System →
 ↻ Select a system →
 ↻ Edit Group →
 ↻ New Group

The scanner creates a group with a default name of **Group n**. **n** increments by one for each new group you create within a system.

Editing a Channel Group Name

MECL

[MENU] → Program System →
 ↻ Select a system →
 ↻ Edit Group →
 ↻ Select a Group →
 ↻ Edit Name →





Follow these steps to enter/edit the group name.

1. The current name displays with the first character of the name highlighted.
2. Rotate the **Scroll Control** to select a new first letter. Press **[6]** to move one character to the right. Repeat the **Scroll Control** action to change the character. To move one character to the left, press **[4]**.
3. Repeat Step 2 until you have entered the system name. Then press  to accept the setting.

Notes:

- Each group name can be up to 16 characters. Abbreviate as necessary to fit.
- The group and system (for conventional, SCAT, and LTR systems) or site (for Motorola and EDACS systems) name alternate in the top line of the display when the scanner stops on a channel.
- Press **[.No]** twice to delete the current character.
- Press **[.No]** three times to clear the entire alpha tag.

Setting the Group Quick Key

To assign a Quick Key to a Group, follow these steps.

[MENU] → **Program System** → 

↻ **Select a system** → 

↻ **Edit Group** → 

↻ **Select the Group** → 

↻ **Set Quick Key** → 

Select a desired quick key for this Group.

Editing Channels

MECL

Once you create a channel group, store channels in that group. See “Programming Channels” on Page85 for specific channel options.

Locking Out Channel Groups

MECL

[MENU] → **Program System** → 

↻ **Select an existing system** → 

↻ **Edit Group** → 

↻ **Select an existing group** → 

↻ **Set Lockout** → 





This setting determines whether the scanner will scan this group of channels. Select your setting, then press .

Lockout — the group is not scanned.

Temporary L/O — the group is not scanned for this session. The L/O is cancelled when you cycle power.

Unlocked — the group is scanned. The default setting is **Unlocked**.

Deleting Channel Groups

MECL

[MENU] → Program System →

↶ Select a system →

↶ Edit Group →

↶ Select a channel group →

↶ Delete Group →

Confirm Delete?

Yes="E" / No= "."

Important: Deleted channel groups cannot be restored. You must re-enter them.

Programming Channels

MECL

Creating a Channel

MECL

[MENU] → Program System →

↶ Select a system →

↶ Edit Group →

↶ Select a channel group →

↶ Edit Channel →

Select an existing channel to edit or "New Channel" to create a new channel. When you create a new channel you are prompted to enter the frequency (for conventional systems) or Talk Group ID (for Trunked systems). Enter the information for the channel, then press to proceed to setting additional channel options.

Editing the Channel Name (Alpha Tag)

MECL

[MENU] → Program System →

↶ Select a system →

↶ Edit Group →

↶ Select the channel group →

↶ Edit Channel →





↶ Select the channel →

↶ **Edit Name** →

Follow these steps to enter/edit the channel name.

1. The current name displays with the first character of the name highlighted.
2. Rotate the **Scroll Control** to select a new first letter.
3. Press **[6]** to move one character to the right.
4. Repeat the **Scroll Control** action to change the character. To move one character to the left, press **[4]**. Press **[.No]** twice to delete the current character. Press **[.No]** three times to clear the entire alpha tag.
5. Repeat Step 2 until you have entered the desired name. Then press to accept the setting.

Notes:

- Each channel name can be up to 16 characters. Abbreviate as necessary to fit.
- The channel name appears on the second line of the display when the radio scans or stops on a channel.

If you do not enter a channel name, the scanner displays the frequency (for conventional systems) or the talk group ID (for trunked systems) when it stops on a channel.

Editing Frequencies

C

[MENU] → **Program System** →

↶ Select a conventional system →

↶ **Edit Group** →

↶ Select a channel group →

↶ **Edit Channel** →

↶ Select the channel →

↶ **Edit Frequency** →

Use the **[0]** to **[9]** and **[.No]** keys to enter or modify a frequency. When you press the first place key, the cursor automatically moves one character to the right.

You can also ↶, clockwise or counter-clockwise to highlight any digit.

Editing the Talk Group ID

MEL

[MENU] → **Program System** →

↶ Select a trunked system →

↶ **Edit Group** →



- ↶ Select a channel group →
- ↶ **Edit Channel** →
- ↶ Select the channel →
- ↶ **Edit TGID** →

To edit the Talk Group ID, enter the Talk Group ID you want using the number keys. Then press .

Setting the Audio Type

MECL

For each channel, you can select the audio type that the channel receives.

- [MENU]** → **Program System** →
- ↶ Select the system →
- ↶ **Edit Group**
- ↶ Select the channel group →
- ↶ **Edit Channel** →
- ↶ Select an existing channel →
- ↶ **Set Audio Type** →
- Select from **All**, **Digital Only**, **Analog Only** →

All — The scanner automatically determines whether the audio is analog or digital.

Digital Only — The scanner only remains on the channel if it is carrying APCO 25 digital audio

Analog Only — The scanner only remains on the channel if it is carrying analog audio.

If you are programming a conventional system and select Analog Only, the scanner prompts you to select the CTCSS/DCS tone setting. See the next section.

Selecting CTCSS/DCS Tones

C

To program a channel with a CTCSS or DCS setting, your conventional system audio must be set to Analog Only first.

- [MENU]** → **Program System** →
- ↶ Select the system →
- ↶ **Edit Group** →
- ↶ Select the channel group →
- ↶ **Edit Channel** →
- ↶ Select the channel →

⤴ **Set Audio Type** →

⤴ **Analog Only** →

At this point you can scroll to CTCSS or DCS and select the subaudible frequency in the CTCSS range or the DCS code.

Off — any signal opens squelch. The default setting is **Off**.

Search — the scanner searches for and displays any CTCSS or DCS tone that accompanies the transmission.

CTCSS — the scanner only opens squelch if the CTCSS tone you select is also present with the signal. The scanner then prompts you to enter or scroll to the desired tone.

DCS — the scanner only opens squelch if the DCS tone you select is also present with the signal. The scanner then prompts you to enter or scroll to the desired tone.

Set Lockout — the scanner does not stop on the channel if the tone you select is present. The scanner prompts you to select a CTCSS or DCS tone.

Note: The scanner does not detect or decode a P25 digital signal if the channel or search has CTCSS/DCS search turned on.

Quick CTCSS/DCS Save

If you set a channel to CTCSS/DCS Search and the scanner detects a tone, when you press [EYES], the first option is **Set found CTCSS/DCS?**

Setting Channel Modulation Method

C

[MENU] → **Program System** →

⤴ **Select the conventional system** →

⤴ **Edit Group** →

⤴ **Select a channel group** →

⤴ **Edit Channel** →

⤴ **Select the Channel** →

⤴ **Set Modulation** →



Auto — the scanner uses the default modulation for the channel. The default setting is **Auto**.

AM — the scanner uses AM (amplitude modulation) for the channel.

FM — the scanner uses FM (frequency modulation) for the channel.

NFM — the scanner uses narrowband FM for the channel.

WFM — the scanner uses wideband FM for the channel.

WFM (Broadcast) — the scanner uses FM Broadcast for the channel.

This setting controls the modulation method used for the channel. In most cases, if you leave this set to **Auto**, the scanner automatically selects the correct modulation type for the channel you are programming.

Setting Channel Attenuation

C

[MENU] → Program System →

↪ Select a conventional system →

↪ Edit Group (existing site) →

↪ Select a channel group →

↪ Edit Channel →

↪ Select a channel →

↪ Set Attenuator →

This setting controls whether the scanner attenuates signals on this channel. Select your setting, then press .

On — the channel is attenuated by about 20 dB.

Off — the channel is not attenuated. The default setting is **Off**.

You can also toggle this setting by holding on the channel and pressing then [7] within 2 seconds.

Setting Channel Priority

C

[MENU] → Program System →

↪ Select a conventional system →

↪ Edit Group →

↪ Select a channel group →

↪ Edit Channel →

↪ Select the channel →

↪ Set Priority →





This setting controls whether the scanner treats the channel as a priority channel while scanning. Select **On** or **Off**, then press

On — when you turn on the Priority feature, the channel will be scanned every 2 seconds.

Off — the channel will not be treated with priority. The default setting is **Off**.

Setting Channel Alert

MECL

[MENU] → Program System →

↪ Select a system →

↪ Edit Group →

↪ Select a channel group →

↪ Edit Channel →

↪ Select the channel →

↪ Set Alert →

Off — the scanner does not alert you when the channel becomes active.

Alert 1 - 9 — the scanner sounds an alert beep to notify you that the channel has become active. You can choose any of 9 different beep types. Once you choose an alert tone, then:

↪ Set Level →

Auto — the scanner automatically sets the channel alert beep to match the master volume level.

Level 1 - 15 — the scanner adjusts the volume of the beep to the level you select.

Set Record

MECL

[MENU] → Program System →

↪ Select a system →

↪ Edit Group →

↪ Select a channel group →

↪ Edit Channel →

↪ Select a channel →

↪ Set Record →

On — the scanner outputs the signal.

Off — the scanner does not output any audio.





Setting Lockout

[MENU] → Program System →

↶ Select a system →

↶ Edit Group →

↶ Edit Channel →

↶ Select a channel →

↶ Set Lockout →

↶ Select a channel group →

Unlocked — the channel is scanned when its quick key is enabled.

Temporary L/O — the channel is locked for this session.

Lockout — the channel is not scanned.

MESL



Copying a Channel

[MENU] → Program System →

↶ Select a system →

↶ Edit Group →

↶ Select a channel group →

↶ Edit Channel →

↶ Select a channel →

↶ Copy Channel →

You see **Copy Channel Copied to Buffer**.

Press [MENU] to return to one level before You see **Paste Channel** as the last list item. At this point you can paste that channel information to another group or compatible system.

MESL

Deleting a Channel

[MENU] → Program System →

↶ Select a system →

↶ Edit Group →

↶ Select a channel group →

↶ Edit Channel →

↶ Select a channel →

↶ Delete Channel →

You see **Confirm Delete? Yes= "E" / No= "."**

Select one to delete the channel or to cancel.

MESL



Searching and Storing

Service Search

Service Search lets you select and search the scanner's preprogrammed search ranges. During service search, the scanner searches starting with the lowest frequency in the search range you select to the highest frequency in the range. There are three ways to do this.

Press **[SRVC]**

[MENU] → **↻ Search for ...** → **⏏**

↻ Service Search → **⏏**

Select the service search range → **⏏**

The other approach is:

⏏ + [SCAN/SEARCH] →

Quick Search? Yes="E" / No="."

Press **[.No]** then to select **Service Search** → **⏏**

The following search ranges appear as you scroll **↻**

Air

CB Radio

UHF CB Radio

Racing

TV Broadcast

FM Broadcast

Police

Marine

Railroad

The scanner searches the service you selected, stopping on any transmission it finds and displaying the frequency. Turn the Scroll Control to change the search direction. An arrow appears, showing the current search direction.

To pause searching, press **[HOLD/RESUME]**. To resume searching, press **⏏ + [SCAN/SEARCH]**. Or, press **[HOLD/RESUME]**.



To lock out a frequency found while searching, press **[L/O]** one time to temporarily lock it out (**Temporary L/O** appears) or twice to permanently lock it out (**Locked Out** appears).

Notes:

- If all frequencies in the search range you selected are locked out, **All Locked!** appears and the scanner does not search the range.
- If the service range you select uses channels (such as CB Radio or Marine), the scanner displays the service channel number.

Quick Search

Quick Search lets you search from the currently-tuned frequency if you are scanning a conventional system or sets the system to ID search if you are scanning a trunked system.

If you are on a conventional system or channel, press **[M] + [SCAN/SEARCH]** to start quick search. **Quick Search? Yes = "E" / No = "."** appears. Press **[HOLD/RESUME]** to go to quick search hold.

Press **[EYES]** to start quick search or **[.No]** to go to the search menu.

Custom Search

Custom Search lets you program and search 10 custom search ranges. You can search any of these ranges simultaneously and select each custom search range you set. During custom search, the scanner searches starting with the lowest frequency in the search range you select to the highest frequency in the range. There are two methods to begin a custom search.

Notes:

- Search ranges are preset. These ranges can be edited. See "Editing a Custom Search Range" on Page94 on Page to change the range.
- You cannot turn off all custom search ranges.

[MENU] → **↻ Search for ...** → **[M]**
↻ Custom Search ... → **[M]**

The other approach is:

[M] + [SCAN/SEARCH] →

Quick Search? Yes="E" / No="."

Press **[.No]** then **↻** to **Custom Search** → **[M]**.



The scanner starts custom search of the custom search range you selected, stopping on any transmission it finds and displaying the frequency. Turn the Scroll Control to change the search direction. An arrow appears, showing the current search direction.

To turn search ranges on or off, press **[0]** and **[1] - [9]**. To hold searching, press **[HOLD/RESUME]**. To resume searching, press **[HOLD/RESUME]**. To lock out a frequency found while searching, press **[L/O]**. There are two different results based on the number of times you press **[L/O]**.

Press **[L/O]** 1 time: **Temporary L/O** appears

Press **[L/O]** 2 times: **Locked Out** appears and the scanner resumes custom search.

If you turn off the active custom search range, the scanner skips to the next custom search range and continues searching.

Note: If all frequencies in all active custom search ranges are locked out, **All Locked!** appears and the scanner does not stop.

Editing a Custom Search Range

You can edit up to 10 custom search ranges. The names of the custom search ranges appear on the display. The default custom search range names appear as **Custom 1**, **Custom 2**, and so on.

[MENU] → **↶** Search for ... → **⊙**
↶ Edit Custom → **⊙**
↶ Custom 1, Custom 2 to Custom 10. → **⊙**

Another approach is

⊙ + **[SCAN/SEARCH]**
Quick Search? Yes="E" / No="."

Press **[.No]** then **↶** to **Edit Custom** → **⊙**.

At this point you can edit each of the settings that comprise a custom search.

Edit Name — lets you edit the custom search range's name.

Edit Srch Limit — lets you view and select the frequency ranges to search. The scanner prompts you to enter the upper and lower search limits.



Set Delay Time — lets you set the amount of time the scanner will delay before continuing to search after a transmission ends.

Set Modulation — lets you set the custom search range's modulation type.

Set Attenuator — lets you set whether the scanner will attenuate reception by 20 dB during search.

Set Data Skip — lets you set whether the scanner will skip data transmissions during search.

Set Step — lets you set the custom search range's step (the gap between frequencies).

Set C-Ch Only — lets you search for a Motorola control channel. If it finds one, the scanner scans the system.

Set Record — if during your listening to the selected service, if a transmission is received, choosing **On** will send an audio signal to the connected audio recording device.

Adjust P25 Level — adjusts the digital decode threshold to match the transmission you are hearing when it receives a strong signal and has a high decode rate.

Search with Scan — sets whether the scanner includes the custom search during scanning. If unlocked, the scanner first scans all selected systems, then searches the selected service searches for the selected hold time (0-255 seconds). Within this menu item are the following settable options

Set Quick Key — lets you assign a Quick Key for the custom search range.

Set Startup Key — lets you decide which custom search range should be unlocked and scanned at power up

Set Lockout — lets you lock the custom search range for this session or permanently as with any other L/O action.

Set Hold Time — sets how long (seconds) the custom search range is checked before the scanner moves to the next programmed entry.

Search With Scan

When you press **[SCAN/SEARCH]** the UBCD996T starts a scan of those sites, channels, etc you have manually programmed or the Uniden preprogrammed data for your metropolitan area that are unlocked and have their System Quick key enabled.





In addition to this scan you can search any of the preprogrammed service or custom search ranges.

While scanning, press . Rotate the **Scroll Control** until you reach the desired service or custom search range. Press **[L/O]** to unlock it. You can also assign a System Quick Key to the search to make it easy to quickly enable/disable the search range for search and scan. The Search with Scan Hold time determines how long the scanner stays on a search before moving on. The default is 2 seconds. See Page 95 to change the Search with Scan settings.

Editing a Service Search

You can change the way service search works for each service. There are also two methods to reach the point of editing.

Method One

[MENU] → **Search for ...** →

Edit Service →

Select a service range:

Air, CB Radio, UHF CB Radio, Racing, TV Broadcast, FM

Broadcast, Police, Marine, Railroad →

Method Two

+ **[SCAN/SEARCH]** →

Quick Search? Yes="E" / No="."

Press **[.No]** then to **Edit Service** → .

At this point you can edit each of the settings that comprise each custom search range.

The following show you how to set the various option settings associated with a Service. For each, your starting operation is

[MENU] → **Search for ...** →

Edit Service →

Select a service range:

Set Delay Time

to select a value from **1 sec, 2 sec, 3 sec, 4 sec, 5 sec, and Off.** →





Set Attenuator

↻ to select to choose an attenuation for all frequencies in the range. →

On — the frequencies are attenuated.

Off — the frequencies are not attenuated.

Set Record

↻ to select to enable a live audio output from **REC** to an audio recording device. →

On — the scanner outputs the signal.

Off — the scanner does not output any audio.

Assigning a Search Range to a Search Key

You can assign any of the Service or Custom Searches to the six Search keys for quick access to your favorite searches.

[MENU] → ↻ **Search for ...** →

↻ **Set Search Key** →

↻ **Select the key to assign** →

↻ **Select a search range** →

Now, to access that search, hold on any channel, then press and the number key **[1]** to **[6]** corresponding to the search range.

The default settings are:

SRCH 1: Custom 1

SRCH 2: Police

SRCH 3: Railroad

SRCH 4: Marine

SRCH 5: TV Broadcast

SRCH 6: FM Broadcast

Saving a Found Channel (Quick Save)

Press **[EYES]** to save a channel's frequency if you hold on a channel or detect a channel, instead of using Direct Entry at another time. The alpha data is also stored. If a GPS unit is attached, the longitude and latitude data is saved and also becomes the name of the channel. For example, if the position is **32°57'33.60 N** latitude and **97°05'34.18 W** longitude, the name saved is **3257.33-09705.34**.





Auto Search and Store

Your scanner's Auto Store feature lets you search for new frequencies in custom search ranges or within a service search range on a conventional system, or new talk group ID's on a trunked system.

Selecting a System

To store frequencies or talk group ID's you find during Auto Store, you must first select a system where the frequencies or talk group ID's will be stored.

[MENU] → ↻ Search for ... →

↻ Search and Store →

↻ Select the system where you want to store the frequencies or talk group IDs →

If no systems are programmed, **No System Stored** appears. If you have already stored too many systems, **Over Limit** appears.

Conventional Search and Store

You can store frequencies into the system you selected in "Selecting a System" above. Otherwise, the scanner stores frequencies in a new group it creates.

Follow the steps in the preceding section but be sure to select a Conventional System. A search option appears that lets you choose from a Custom Search to the other service search ranges previously mentioned (Public Safety, News...etc). **Turn the Scroll Control** until the search range you want appears, then press to select it. One of the search ranges appears.

If frequencies in your selected search range are all locked out, **All Locked!** appears and the scanner does not store any frequencies.

When you select a search range, the scanner looks for active frequencies within that range. The top line of the display alternates between the system name and the search range name while **SEARCH AND STORE** appears beneath it. The second line changes to **Memory Check** when the scanner detects a transmission while it is checking to see if the frequency has already been stored.

When the scanner finds an active transmission, it checks to see if the frequency has already been stored in the system. If the frequency has already been stored, the scanner continues to search. If the frequency has not been stored, it stores the frequency into a group named Found Channels, then resumes searching. The scanner creates this group if it doesn't already exist.





Trunked Search and Store

You can store talk group ID's into the system you selected in "Selecting a System". Otherwise, the scanner stores talk group ID's in a new group it creates.

Note: Trunked system search and store does not work if an EDACS SCAT system is selected, a system with no frequency is selected, the quick key to which the system belongs is turned off, and the group you selected to store found talk group ID's contains more talk group ID's than the maximum set in Max Auto Store.

To store a trunked system, follow the beginning steps in Selecting A System above. When you select a Trunked System and press , the scanner enters TGID Search and Store mode.

When you select a trunked system, the scanner looks for active talk group ID's within that range and **ID SEARCH AND STORE** appears and scrolls across the display's lower line while the system/site name appears on the display's upper line.

When the scanner finds an active talk group ID, it checks if the talk group ID has already been stored in the site. If it has, the scanner continues to search. If the talk group ID has not been stored, it stores the talk group ID into a group named **Found Channels**, then resumes searching. The scanner creates this group if it does not already exist.



Using the Close Call Feature

Your scanner's Close Call™ feature lets you set the scanner so it detects, displays the frequency of, and lets you hear a nearby strong radio transmission. You can set the scanner so the Close Call feature works “in the background” while you are scanning other frequencies, turn off normal scanning while the Close Call feature is working, or turn off the Close Call feature and use the scanner normally. You can set the scanner so it alerts you when the Close Call feature finds a frequency. You can also set the frequency band where you want the scanner to look for transmissions. To toggle Close Call mode, press **[SQ/☉]**. When the feature is on, **CC DND(☉)** or **CC Pri(☉)** and their indicating icons appear on the display. Normal operation is briefly interrupted about every 2 seconds.

Notes:

- The Close Call feature works well for locating the source of strong local transmissions such as mobile and handheld two-way radios in areas with no other strong transmission sources. Several factors affect Close Call performance, however. Performance is increased with higher transmit power, receive antenna tuned to the target band, and a low background RF level. Other than the antenna, you have no control over these factors, but they explain why performance might vary by both location and time.
- The Close Call feature cannot detect satellite dishes or any transmitter with a frequency above or below the frequency ranges listed under the Set CC Bands: option on Page 102.
- The Close Call feature works better with some types of transmissions than others. It might not correctly display frequency information for transmitters using a highly directional antenna (such as an amateur radio beam antenna) or if there are many transmitters operating at the same time in the same area.

Setting Close Call Options

[MENU] → ☰ **Close Call** → ☑

Next, turn the Scroll Control ☰ to select an option.

Close Call Only — Lets you set the scanner only for Close Call searching. The scanner does not scan frequencies or channels when this option is turned on. To select this option, press ☑.

CC Auto Store — Lets you select whether the scanner automatically stores Close Call hits into channels. If you turn this option on, the scanner starts Close



Call mode and stores any Close Call hits, up to the maximum you specified in the **Max Auto Store** setting. If the scanner stores more hits than this setting, it stops auto store operation.

Turn the Scroll Control  to display an option, then press .

Set CC Mode — Lets you select the Close Call mode. If you set **CC DND** or **CC Pri**, then every 2 seconds the scanner switches the filter settings to the ones set by the CC Bands option.

off — Close Call is turned off for all modes.

CC DND (Do Not Disturb) — The scanner checks for a Close Call hit every 2 seconds only if the scanner is not currently stopped on a transmission. If the scanner is on a transmission the scanner waits until the signal ends to perform a Close Call check. This prevents breaks in audio during Close Call checks.

CC Pri (Priority) — Checks for a Close Call hit every 2 seconds.

Set CC Override — Lets you select how the Close Call feature works with other scanning activities. If you turn this option off, when the scanner detects a Close Call signal, **CC Found! Press Func Key** appear for the time you set in **Set CC Pause**. Press  when this appears to jump to and hold on the frequency. If this option is turned on, the scanner overrides the current channel and goes to the Close Call hit. The scanner displays **CC Found! Press Any Key**. When you press a key, the frequency appears.

Set CC Alert — Lets you select how the scanner alerts you when it receives a Close Call signal. You can select from these options.

•**Select Beep** — The scanner beeps when it receives a Close Call signal. You can set the beep alert in the following manner.

off — the scanner does not beep

Alert 1-9 — The scanner sounds a specialized beep to notify you of a Close Call hit. When you select an alert type, the scanner automatically enters the setting of the Alert volume level. Each alert has a unique one or sound pattern.

Set CC Pause — Lets you select how long the scanner waits after a hit before it returns to the previous operation. Your options are:

3/5/10/15/30/45/60 sec.

Infinite — The scanner stops and requires you to manually select another operation to enable its return.





Set CC Bands — Lets you select the Close Call band settings. You can turn the following bands on or off.

VHF Low 1 — (25.0000 - 53.9800 MHz)

VHF Low 2 — (54.0000 - 107.9000 MHz)



Air Band — (108.0000 - 136.9875 MHz)

VHF High 1 — (137.0000 - 224.9800 MHz)

VHF High 2 — (225.0000 - 319.9750 MHz)

UHF — (320.0000 - 512.0000 MHz)

800MHz+ — (764.0000 - 775.9875 MHz, 794.0000 - 956.0000 MHz, 1240.000 - 1300.0000 MHz)

Use the **Scroll Control**  to select a band, press , then use the **Scroll Control** to select **On** or **Off** and press . Turning off undesired bands speeds up Close Call operation (works for all frequencies listed above).

Close Call Hits

When the scanner detects a Close Call hit, it alerts you according to the Override and Alert settings in the previous section.

While listening to a Close Call hit, you can press **[HOLD/RESUME]** to hold on the hit frequency, press  to quickly save the frequency into memory, press **[L/O]** to lock out the frequency from Close Call and Search operation, or wait for the transmission to end. If you are in Close Call Only or Close Call Override mode, and you do not press any key, the scanner returns to its previous operation after the transmission ends and the set delay time expires.

If you are holding on the frequency, press **[HOLD/RESUME]** again to resume the previous operation.

Close Call Hits are just the last 10 hits received in Close Call mode. The hits go away when you cycle power (if you want to store it “permanently” press  when the scanner is on the frequency; the scanner then stores the frequency into the “Close Call” system which does show up in the systems list).

Close Call Hits with Scan

When you turn on this option, the scanner automatically stores and scans the last 10 Close Call hits received. You can assign a Quick Key to this special scan and you can also set how long the scanner will wait after the signal stops before





resuming scan. This lets you continue to hear transmissions detected with the Close Call feature, even after you are no longer close enough to receive it as a Close Call hit. Follow these steps to set up the option.

[MENU] → **Close Call** →

Hits with Scan →

Set Quick Key or **Set Lockout** or **Set Hold Time** →

Set the available option as you would for other menu items.

This special channel group is automatically cleared whenever you cycle the scanner's power. To permanently save one of the channels, press **[EYES]** when the scanner is stopped on one of the frequencies. To keep the scanner from repeatedly stopping on an annoyance hit, press **[L/O]** when the scanner stops on the frequency.



Search and Close Call Options

The settings in this section affect custom searches, service searches, and Close Call operation. The following table shows what options are available for various search modes

Setting	Service Search ¹	Custom Search ¹	Quick Search	Search and Store	Close Call	CC Auto Store	CC Hits System
Freq. Lockouts	•	•	•	•	•	•	
Broadcast Screen		•	•	• ²	•	•	
CTCSS/DCS Search	•	•	•	•	•	•	
Repeater Find		•	•		•		
Max Auto Store				•		•	
Set Delay Time			•		•		•
Set Modulation			•		•	•	
Set Attenuator			•		•	•	
Set Data Skip	•		•	• ³	•	•	•
Set Step			•				
Set Record			•		•		•
Adjust P25 Level	•		•		•		•

1 — Valid only for searching a range using Search with Scan.

2 — Valid only for storing a frequency from Search and Store.

3 — Valid only for storing a frequency from Service Search.

Managing Locked-Out Frequencies

While searching or during Close Call operation, if you press [L/O] while the scanner is stopped on a frequency, that frequency is locked out of these modes. The temporary L/O frequency limit is 250. The permanent L/O frequency number limit is up to 250.



Unlocking All Frequencies

[MENU] → ↻ Srch/CloCall Opt → ●

↻ Freq Lockouts → ●

↻ Unlock All → ●

The scanner prompts you to confirm deletion. To confirm and delete all locked-out frequencies, press . If no frequencies are locked, you see **Nothing Locked** Press Any Key. Otherwise, to exit, press any key to backstep.

Reviewing Locked-Out Frequencies

[MENU] → ↻ Srch/CloCall Opt → ●

↻ Freq Lockouts → ●

↻ Rvw Search L/O → ●

The scanner displays the first locked-out frequency and prompts you to unlock the frequency. Press to unlock the frequency. Or, rotate the Scroll Control or press to select a different frequency. If there are no frequencies to review, you see **Nothing Locked Press Any Key**. Otherwise, to exit, press any key to backstep.

Searching for Subaudible Tones

[MENU] → ↻ Srch/CloCall Opt → ●

↻ CTCSS/DCS Search → ●

↻ On or Off → ●

This setting controls whether the scanner will search for a subaudible tone when it stops on a transmission during search or Close Call operation.

On — The scanner searches for and displays any subaudible tone found.

Off — The scanner does not search for subaudible tones.

Note: This feature does not operate when the scanner is in AM/WFM/FMB modulation mode.

Screening Out Broadcast Sources

[MENU] → ↻ Srch/CloCall Opt → ●

↻ Broadcast Screen → ●



This setting determines whether the scanner automatically ignores transmissions found during Custom Search, Quick Search, or Close Call operation that are on common broadcasts, paging systems, and other annoyance radio sources.

Note: Broadcast screening does not work in All service search ranges.

Set All Band On — turns on broadcast screen on each band.

Set All Band Off — turns off broadcast screen on each band.

Set Each Band — lets you set broadcast screen only on **specific** bands you select. **On** or **Off** appears next to each option. Turn the **Scroll Control** to select an option then press to change the setting.

Pager — the scanner skips known paging system frequencies.

FM — the scanner skips known FM frequencies.

UHF TV — the scanner skips known UHF TV frequencies.

VHF TV — the scanner skips known VHF TV frequencies.

Band 1-10 — select the custom band where you want to screen out broadcast sources.

Program Band — brings you to a menu setting to let you program a custom frequency range for broadcast screen. Turn the **Scroll Control** to select an option then press to change the following setting.

To set the custom range of a band, select one and press to set the limit.

Band 1-10 — select the group where you want to screen out broadcast sources.

Set Lower Limit— enter the lower limit of the frequency range, then press to set it.

Set Upper Limit — enter the upper limit of the frequency range, then press to set it.

To set the custom range of a band, select one and press to set the limit.

Finding Repeater Output Frequencies

[MENU] →

Srch/CloCall Opt →





↶ Repeater Find →

↶ On or Off →

This feature sets whether the scanner tries to tune to a repeater output frequency during Custom Search, Quick Search, or Close Call operation when it detects a transmission on a repeater input frequency. Since you can normally only hear one side of a conversation when you listen to an input frequency transmission, turning this feature on can let you hear both sides of the conversation where a standard difference frequency is set between the input and the output, to and from the repeater.

On — The scanner automatically applies repeater reverse to detected transmissions. If the scanner detects the transmission on the output frequency, it beeps, **Repeater Found** appears, and it remains on the output frequency until transmissions end. If it does not detect a transmission on the output frequency, it remains on the original frequency.

Off — The scanner does not try to find the output frequency.

Setting the Maximum Auto Store Value

[MENU] → ↶ Srch/CloCall Opt →

↶ Max Auto Store →

This value sets how many hits the scanner will automatically store when it is in either Search and Store or Close Call Auto Store mode. Use the number keys to enter a value from 1 - 256, then press . The default value is 100.

When the scanner exceeds the maximum number of hits you set, it stops the auto-store operation.

Setting the Modulation Type

This setting controls the modulation method used for the frequency band and for Quick Search and Close Call operations. In most cases, if you leave this set to **Auto**, the scanner automatically selects the correct modulation type for the system you are programming.

[MENU] → ↶ Srch/CloCall Opt →

↶ Set Modulation →

Auto — the scanner uses the default modulation for the frequency band. The default setting is **Auto**.





AM — the scanner uses AM (amplitude modulation) for the frequency band.

FM — the scanner uses FM (frequency modulation) for the frequency band.

NFM — the scanner uses narrowband FM for the frequency band.

WFM — the scanner uses wideband FM for the frequency band.

WFM (Broadcast) — the scanner uses FM Broadcast for the frequency band.

Setting Attenuation

Turn on this setting if you are near other strong signal sources. Attenuation sometimes helps to reduce interference and desensitization that strong signals create.

[MENU] → **Srch/ClcCall Opt** →

Set Attenuator →

This setting controls the attenuator for Quick Search and Close Call operation. Select your setting, then press .

On — Reception is attenuated by about 20 dB.

Off — The attenuator is off.

Setting Data Skip

[MENU] → **Srch/ClcCall Opt** →

Set Data Skip →

This setting controls how the scanner behaves when it stops on a channel that has a data signal.

On — the scanner stops briefly on the channel, but then immediately resumes scanning automatically.

Off — the scanner remains on the channel until the transmission stops. The default setting is **Off**.

Note: If you are trying to test the Close Call feature with a nearby transmitter (such as a CB) and you do not talk into the transmitter, the scanner detects this unmodulated carrier as data and skips the frequency when Data Skip is on. Turn the feature off or talk into the transmitter to modulate the carrier.

This setting is ignored for AM/WFM/FMB channels.





Setting the Delay Time

[MENU] → Srch/CloCall Opt →

Set Delay Time →

This setting determines how long the scanner waits after a transmission ends before resuming Quick Search or Close Call operation.

1-5 sec — The scanner waits the set amount of time after the transmission ends before resuming. The default setting is 2 sec.

off — The scanner resumes immediately when the transmission ends.

Setting the Search Frequency Step

[MENU] → Srch/CloCall Opt →

Set Step →

This setting lets you select the frequency step used for setting the channels.

Auto — The step is based on the band (see the table at the front of the manual). This is also the default setting.

5.0 kHz, 6.25kHz,
7.5 kHz, 8.33kHz,
10.0 kHz, 12.5 kHz,
15.0 kHz, 20.0 kHz,
25.0 kHz, 50.0 kHz,
100.0 kHz

The scanner uses the selected step.

Setting Record

You can set the RECOrd Output jack to provide an audio signal to a sound recording device (tape, PC, flash memory) for live recording of transmissions.

[MENU] → Srch/CloCall Opt →

Set Record →

On — enables an output to an audio recorder at the **RECORD OUT** jack.



off — disables an audio signal at the output jack.

Adjust P25 Level

You can select the best threshold for the APCO mode.





[MENU] → ⤷ Srch/CloCall Opt → 
 ⤷ Adjust P25 Level → 

Auto — The automatic adjust feature is enabled.

Manual — you can set the threshold manuals depending on your circumstances.

Default — sets the factory default value.

Priority Scan

If you activate a Priority Scan while scanning, the radio interrupts its scan every two seconds to check the priority channel (P-Ch). **PRI** appears on the screen. There are two ways to set Priority Scan.

1. Press [**PRI**] to set one of the following Priority Scan levels in Scan / Scan Hold mode.



off — Normal scanning. The scanner provides no special treatment for Priority Channels.

On — The scanner scans all unlocked channels and also checks those designated as Priority. While scanning a conventional system, the scanner interrupts every 2 seconds and checks the priority channels in each unlocked conventional system. Priority channels in lower priority key numbered systems (starting from 1) have highest priority. **PRI** appears when you select this mode.

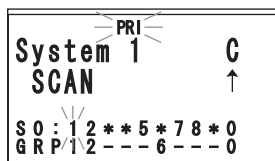
Plus On — The scanner only scans priority channels in unlocked conventional systems. **PRI** flashes when you select this mode.



2. You can choose how the scanner treats Priority Channels using the Menu options.

[MENU] → ⤷ Set Priority → 
 ⤷ Choose Off, On, or Plus On → 



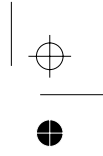
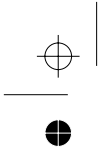

This page is intentionally blank.

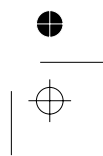
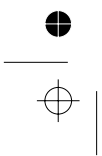

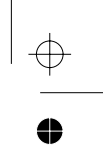
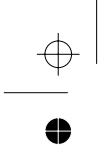

This page is intentionally blank.

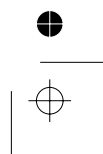
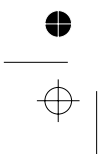

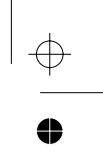
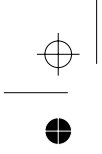

This page is intentionally blank.

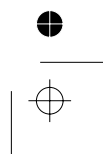
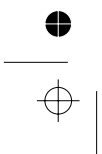





Fire Tone-Out

Your scanner can be set to respond to fire tone-outs, a system comprised of standardized two-tone sequential paging, short one-tone paging, and long group tone paging. You can save up to 10 settings. When you select a setting in standby mode, the scanner also monitors for any other setting that uses the same transmit frequency, modulation, and attenuation settings. To quickly switch to Fire Tone-Out mode, press  and then **[SQ]**.

You need tone-out setup information from the agency you wish to monitor. Check with your local agency or on-line resources.

Note: The Fire Tone-Out feature is not used in Australia or New Zealand.

Setting Tone-Out Standby





[MENU] →  **Tone-Out for...** → 
 **Tone-Out Standby** → 



Turn the **Scroll Control**  to select which of the ten tone-outs to monitor. Or, while holding on any channel, press then **[SQ]** to quickly switch to Tone-Out Standby, then rotate scroll to select the settings to monitor. All tone-outs that have the same frequency, modulation, and attenuation setting as the one you select, are also monitored.

In standby mode, the display cycles through all monitored tone-out settings. Regardless of the current display, the scanner always alerts on any received tone-out that matches a stored setting.

If you press **[HOLD/RESUME]** while in standby mode, the scanner temporarily exits the mode and you hear all transmissions on that frequency. No alerts sound, even if a tone-out matches one you have stored. Press **[HOLD/RESUME]** again to return to standby mode.

Setting Up Tone-Out

[MENU] →  **Tone-Out for...** → 
 **Tone-Out Setup** → 

Scroll to select the tone-out (1 - 10) you want to program, then press . Then you can scroll to any of the following settings and press  to select and modify the selected settings:

Edit Name — Sets the name for the selected tone-out setting.

Set Frequency — Sets the tone-out's RF frequency parameters. Then select:



- **Edit Frequency** — Enter the desired frequency that the scanner should monitor for the tone-out.
- **Set Modulation** — Set the modulation type for the paging signal. Next choose the modulation setting:

Auto — The scanner uses the default modulation for the frequency band. If the default modulation is AM, WFM, or FMB, the modulation operates as FM.

FM — The scanner uses FM for the frequency band. This is the default setting.

NFM — The scanner uses NFM modulation.

Set Attenuation — Turn the Scroll Control to select **On** or **Off**.

Set Tone — Sets the audio tone frequency for the page. Then choose the Tone setting.

- **Edit Tone A** — Set the audio frequency for Tone A
- **Edit Tone B** — Set the audio frequency for Tone B\

Notes:

- For two-tone pages, enter a value for A and B.
- For one-tone pages using short tones of less than 3.75 seconds, enter the tone value for A, and 0 (zero) for B.
- For long-tone pages, such as group pages of more than 3.75 seconds, enter 0 (zero) for A and the tone value for B.

Set Delay Time — Sets the time the scanner remains in monitor mode after the scanner receives a page and the carrier drops.

1-5 sec — the scanner resumes standby mode after the carrier drops and the selected time expires.

Infinite — you must press **[HOLD/RESUME]** after a page to resume standby mode.

Off — the scanner resumes standby as soon as the carrier drops after a page.

Set Alert — Sets the alert the scanner uses when it receives an alert.

Alert 1 - 9 — scroll to select the alert tone pattern, The scanner sounds each alert as you scroll to its numbered value.

Off — the scanner does not sound an alert.





After you select an alert pattern, the scanner prompts for the alert level for a received alert. Level options 1 to 15 sets a fixed audio level independent of the main volume setting. **AUTO** uses the main volume setting for the alerts.

Tone-Out Multi-Channel Monitoring

The scanner can check multiple tone combination pages for channels whose settings are the same. To achieve this, set the channel to the same frequency, modulation, and attenuation. For example, the scanner checks tone combinations for channel 1 to channel 3 for the following settings.

	Frequency (MHz)	Modulation	Attenuator	Tone A (Hz)	Tone B (Hz)
Ch 1	137.0000	Auto (NFM)	Off	1000.0	2000.0
Ch 2	137.0000	Auto (NFM)	Off	2200.0	3200.0
Ch 3	137.0000	Auto (NFM)	Off	1500.0	2500.0
Ch 4	137.0000	NFM	Off	1800.0	2800.0
Ch 5	137.0000	FM	Off	2000.0	3000.0
Ch 6	138.0000	Auto (NFM)	Off	1000.0	2000.0

Although set to Auto, if the band default is anything other than FM or NFM, modulation will always be FM.

If you switch to Tone-Out Standby Mode for Multi-Channel Monitoring, the display switches every 2 seconds to show the frequency it is checking. However, it is, at the same time, checking all frequencies for Tones. If one is detected, it switches to Tone-Out Hold mode.





Location-Based (GPS) Scanning

The UBCD996T can make use of data transmitted from an attached GPS unit that lets the radio automatically enable and disable systems based on the geographic information you provide such as:

- Latitude (the center of the range)
- Longitude (the center of the range)
- Range (the radius of a circle around the latitude and longitude coordinates selected from .5, 1, 3, 5, 10, 20, 30, and 50 miles.

You set the longitude and latitude to approximate the center of a geographic entity such as your local city and set the range to encircle that center point. By doing so you set aside reception of an adjacent city that otherwise might be undesirably received from one extremity of your city.

In addition, all geopolitical areas are not perfect circles. Therefore you can accommodate these variations by entering multiple sites for the system, even though the system actually has one site, and use different location settings for each of those additional sites.

See the programming section for specific steps required to apply location data to a radio system.

GPS Compatibility

The GPS must have serial output, and be capable of outputting standard NMEA sentences GGA and RMC. (See "NMEA-0183 ver.3.01" which can be found on the web.) Be sure to set the GPS to output NMEA.

Connecting Your Scanner to a GPS Device

To use the Location Based features of the scanner, you must connect a GPS to the unit. Use the cable provided by the GPS manufacturer. Make sure that their cable terminates in a female, 9-pin serial connector. Insert that plug into the male, 9-pin socket on the back of the scanner labeled **REMOTE/GPS**. Once the GPS is connected, refer to the sections dealing with inputting selections to enable Location Based feature operation.

Initial GPS Operation

When the scanner first starts receiving a signal from the GPS, it briefly displays **GPS Connected** and silently locks and unlocks all radio sites according to your





current location. If you have a lot of data programmed, it might take the scanner a couple of minutes to complete the process. Once the scanner completes the initial GPS review, if you move into or out of an area covered by a radio site, the scanner beeps and displays the name of the system and whether it is being locked or unlocked.

Note: The GPS function temporarily locks out sites and systems when you move out of their range. If you cycle power, all systems are unlocked until the scanner reacquires the GPS signal and completes the initial GPS review.

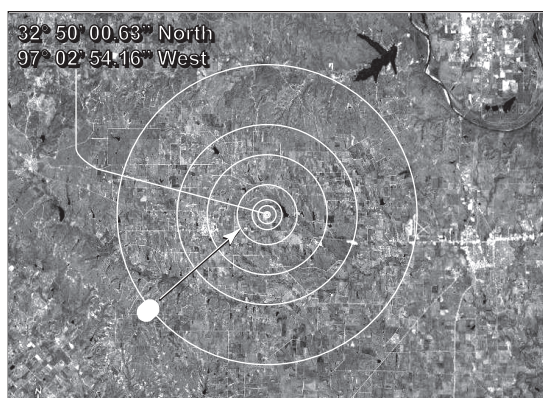



Non-Radio Location Based GPS Features

When connected to a GPS, you can program specific location information which will trigger an alert from the scanner. The following geographically based values are typical of the use you might find valuable while traveling. Use the menu to input the necessary data to enable each.

- Dangerous Xing — Stores location, and direction of travel. If you are in range, traveling in a direction that will take you to that Point, the radio sounds an alert at .5, .25, and .1 miles from the point.
- Dangerous Road — Stores location, direction of travel, and speed. If you are traveling at a speed greater than that specified and if you are within range of the set location, the scanner sounds an alert at .5, .25, and .1 miles from the point.
- Points of Interest (POI) — Stores location and range. If you approach the set location, the radio sounds an alert.

In general, an alert based on location is comprised of the following data:

- Latitude
- Longitude
- Speed (optional setting)
- Name (optional setting)
- Alert Type and Sound level (optional setting)
- Direction (optional setting)

There are four setting conditions that can be set to result in alerts:

- A speed setting greater than zero with no direction entered. This results in an alert based only on speed in any direction.
- A speed setting greater than zero with a specific direction entered. This triggers an alert when the speed is exceeded but only in the specified direction.
- Speed is equal to zero and a direction is entered along with a location. This setting is used for a dangerous intersection alert.
- Speed is set to zero and no direction is entered but only location. This is a point of interest alert.

By pressing **[Func] + [GPS]** you can next choose from a setting for Speed, Intersection, or Point of Interest.





By pressing & holding **[GPS]**, you can select a location type and store current location data.

The following table shows the attributes available for each category. Note that some options are different for a specific location type. Refer to the information that follows to set those specific attributes.

Menu Option	POI	Dangerous Xing	Dangerous Road
New Location	•	•	•
Edit Name	•	•	•
Set Type (edit)	•	•	•
Set Alert Beep	•		
Set Alert Volume		•	•
Set Location Info	•	•	•
Set Heading		•	•
Set Range	•		
Set Speed Limit		•	•
Set Lockout	•	•	•
Delete Location	•	•	•

Setting the Options

[MENU] → **Program Location** →

↻ Select a location type (POI, Dangerous Xing, or Dangerous Road). →

↻ **New Location** →

The scanner assigns a sequentially created number to the location.

↻ **Edit Name** →

Use the Scroll Control and to change the name the scanner assigns to the location to one you prefer. You could, for example, enter the name of the place or the Route Number.



⤷ **Set Type** → At this level you have an opportunity to reassign or edit the location type you first selected and set the location to either one of the other types or change the data in an existing location.

This option also lets you associate a new Alert Tone to POI. Dangerous Xing and Dangerous Road each have unique Alert Tones that cannot be changed. You can still set a different volume level with the new Alert Tone for all three types.

⤷ **Set LocationInfo** → Input the latitude and then the longitude.

⤷ **Set Lockout** → As you near your target location, an alert sounds at **0.5**, **0.25**, and **0.1** mi. If you hear the first and prefer to not hear any others that occasion, simply press **[L/O]** to disable the operation while keeping all the data for another time. You can use the menu **Lockout** option as well. When you set the location system to **Temporary L/O** and move away more than four miles and then come back again, **L/O** status is automatically canceled. If you turn off the switch, the scanner is unlocked.

Deleting a Location

If you have programmed a location that you no longer want, you can delete it as follows.

[MENU] → **Program Location** →

⤷ Select a location such as **Dangerous Xing** →

⤷ Location to be deleted →

⤷ **Delete Location** →

⤷ **Confirm Delete? Yes="E" / No="."** →

Make your choice to either delete the location or to cancel your action.

For POI Only

⤷ **Set Alert Beep** → Choose from **Off**, no tone sounds or one of the alert melodies **Alert 1** to **Alert 4**.

Once you make a Tone selection you are then asked to assign a volume level to that selection.

Set Alert Volume → select from 15 sound levels, plus Auto. As you rotate the **Scroll Control** the Alert tone you set is played louder and louder. Press to select a volume level. You can also select Auto, a level that is the same setting as your master volume control setting.



↻ **Set Range** → Input how far away the alert sounds for the site (only available for POI's)

For Dangerous Xing, and Dangerous Road Only

The Alert Tone is fixed.

↻ **Set Alert Volume** → select from 15 sound levels, plus Auto and Off. As you rotate the **Scroll Control** the Alert tone is played louder and louder. Press to select a volume level. You can also select no sound (Off) or Auto, a level that is the same setting as your master volume control setting.

For Dangerous Xing and Dangerous Road sites there are two additional settings:

↻ **Set Heading** → You can input the compass direction to the site from your present location or, you can select All Range.

For example: If the **Dangerous Road** location is toward the Northeast and you are driving in that direction, then choose **NE (45°)**

If you know you will be driving a course which is not a fairly straight line to that site, choose **All Range** which will trigger the alert regardless of direction as long as the other requirements (range, speed) are met.

If you travel in a Northeast direction and do not travel either side of a northeast line by up to 22 degrees, the alert system will function.

↻ **Set Speed Limit** → Choose from 0, through 100 MPH in 5 PHM steps or the equivalent in KPH for metric usage.

GPS Display Mode

If you press **[GPS]**, the scanner switches to a GPS display mode. In this mode, you can see location information as well as information about your position relative to the selected POI. The third line of the screen shows **Off** if no POI is selected.

Rotate the **Scroll Control** to select different POI's.

Press **[Func]** () + **[GPS]** to toggle the Display mode in order.

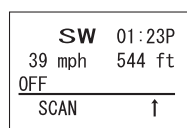

GPS DATA Display

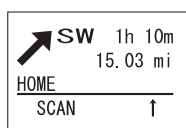

ETA Display

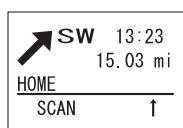

Clock Display



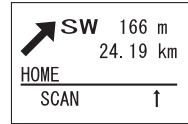
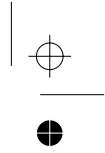
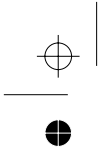

Elevation Display

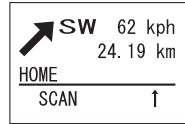

Speed Display

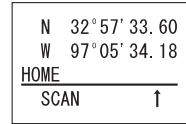

Location Display

GPS Review Location Mode

If you have programmed data for a Point of Interest, Dangerous Crossing, and a Dangerous Road, you can review each set on a screen dedicated to showing just that data.

Press **[EYES]** in GPS Mode.

The most recent stored location is displayed. Use the Scroll Control to display the next screen for review.

Important: While you are in normal GPS mode or Scan Mode and you press and hold **[GPS]** for 2 seconds, location data at that point is stored. The scanner opens a dialog to store your current location. The default name is T YYMMDD hhmms that indicates the date and time you stored the location point.

The data is put into memory and you are given the opportunity to designate the location as POI, Dangerous Xing, or Dangerous Road.

However, if you are in Review Mode and press and hold **[GPS]**, the data of the new point will overwrite the currently displayed data.

The some of the following keys have a somewhat different function while in GPS Review Mode.

[GPS] — Press and Hold: overwrites and stores current location data

[MENU] — returns to GPS Mode.

[L/O] — changes the status of the currently displayed location data.

[L/O] — press and hold to unlock all locations of the current type (POI, DXG, or DRG)

Unlocked All TTTs? and **Yes="E" / No="."** is displayed. **TTT** shows the location type as POI, DXG or DRD.

[L/O] — press and hold in Function Mode unlocks all locations of all types.

Unlocked All Location? and **Yes="E" / No="."** is displayed.

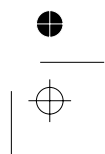
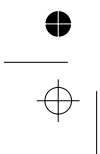

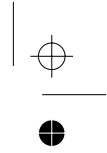
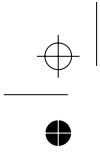

[.No] — returns to GPS Mode.

[EYES] — lets you edit a location details

[SCAN/SEARCH] — enter scan mode.

[HOLD/RESUME] — enter Scan Hold mode

☐ — enter Function Mode.

↻ — select a programmed location from all stored locations. The location data is stored in the order POI, Dangerous Xing, and Dangerous Road. Then, within each category, the data is stored by the programmed name.

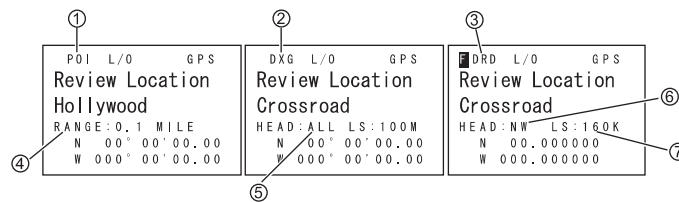

1. POI — Indicates a Point of Interest location.
2. DXG — Indicates a Dangerous Crossing location.
3. DRD — Indicates a Dangerous Road location.
4. Range — Indicates the programmed distance to your POI.
5. Head — Indicates the selected heading to the designated dangerous Crossing from any direction.
6. Head — Indicates the selected heading to the designated dangerous Road from a set direction.
7. LS — Indicates the maximum Speed Limit you set.

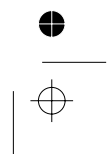
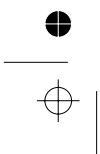

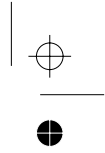
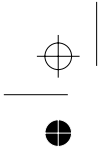

Care and Maintenance

General Use

Turn the scanner off before disconnecting the power.

If memory is lost, simply reprogram each channel.

Always press each button firmly until you hear the entry tone for that key entry.

Location

Do not use the scanner in high-moisture environments such as the kitchen or bathroom.

Avoid placing the unit in direct sunlight or near heating elements or vents.

If the scanner receives strong interference or electrical noise, move it or its antenna away from the source of the noise. If possible, a higher elevation might provide better reception.

Also try changing the height or angle of the antenna.

Cleaning

Disconnect the power to the unit before cleaning.

Clean the outside of the scanner with a mild detergent.

To prevent scratches, do not use abrasive cleaners or solvents. Be careful not to rub the LCD window.

Do not use excessive amounts of water.

Repairs

Do not attempt any repair. The scanner contains no user serviceable parts. Contact the Uniden Customer Service Center or take it to a qualified repair technician.

Birdies

All radios can receive “birdies” (undesired signals). If your scanner stops during Scan mode and no sound is heard, it might be receiving a birdie. Birdies are internally generated signals inherent in the electronics of the scanner.

Press **[L/O]** to lock out the channel.

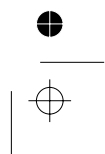
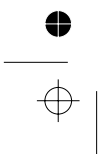



Troubleshooting

From time to time, Uniden might update the UBCD996T's firmware to change the scanner's performance or incorporate new features. These updates can be applied by you using the supplied PC cable and the software that we will provide. Please note that firmware data must be input by means of the front panel serial cable connection, not the rear connector. We recommend you visit the Uniden web site periodically to check for the latest updates.

However, if you believe your UBCD996T is not performing properly, try these suggestions.

Problem	Possible Cause	Suggestion
The scanner doesn't work.	The scanner might not be receiving any power.	Make sure the AC adapter is connected to an AC outlet and the scanner. The display should light and cycle if you repeatedly press [VOL]
		If there is a wall switch that controls power to the AC outlet where you connected the AC adapter, make sure it is on.
Improper reception.	The antenna might need to be adjusted.	Check the antenna connection or move or reposition the antenna.
		Move the scanner.
		You might be in a remote area that could require an optional multi-band antenna. Check with your dealer or local electronics store.
Scan won't stop.	The squelch might need to be adjusted.	Adjust the squelch threshold. See "Turning On the Scanner and Setting the Squelch" on Page 45.
	The antenna might need to be adjusted.	Check the antenna connection.
	One or more channels might be locked out.	Make sure the channels you want to scan are not locked out.
	The channel's frequency might not be stored in memory.	Make sure the channel's frequency is stored in the scanner's memory.
	The channel might not be active.	Wait for a transmission on the channel.



Problem	Possible Cause	Suggestion
Scan won't start.	You must press [SCAN/SEARCH] to scan.	Press [SCAN/SEARCH] .
	The squelch might need to be adjusted.	Adjust the squelch threshold. See "Turning On the Scanner and Setting the Squelch" on Page 45.
	One or more channels might be locked out.	Make sure the channels you want to scan are not locked out.
	The antenna might need to be adjusted.	Check the antenna connection.

If you experience difficulty while in TrunkTracker™ mode, try the following steps.

Problem	Possible Cause	Suggestion
Scanner won't track a trunked system.	The system might not be one your scanner can scan.	Change to another system and try scanning that system.
	The data frequency might be missing.	Enter the data frequency.
	The scanner might need to be changed to a Type 1 scanner setup.	Change to a Type 1 scanner setup. See the programming instructions on the web at www.uniden.com/scanners .
	The system you are trying to scan might be LTR or EDACS.	Set the scanner to scan LTR or EDACS systems. See the programming instructions on the web at www.uniden.com/scanners .
	No ID's have been programmed.	Program one or more ID's or use the ID Search mode.
	The ID's you have stored are not active.	Wait for the ID's to become active or scan another system.

Problem	Possible Cause	Suggestion
Scanner won't acquire the data channel.	The squelch might need to be adjusted.	Adjust the squelch threshold. See "Turning On the Scanner and Setting the Squelch" on Page 45.
	The frequency used for the data channel might be missing.	Check your frequency list for the data channel.
Missing replies to conversations.	The scanner might need to be changed to a Type 1 scanner setup.	Change to a Type 1 scanner setup. See the programming instructions on the web at www.uniden.com/scanners .
	The fleet map might be incorrect.	Try another preset fleet map or program your own fleet map.
	One or more of the system's frequencies might not be entered.	Make sure all the system's frequencies have been entered.
	The system you are trying to scan might be LTR or EDACS.	Set the scanner to scan LTR or EDACS systems. See the programming instructions on the web at www.uniden.com/scanners .

If you still cannot get satisfactory results while using your scanner or if you want additional information, please call or write the Uniden Parts and Service Division.

The address and contact number are listed in the Warranty at the end of this manual.

If you have Internet access, you can visit www.uniden.com.au (Australia) or www.uniden.co.nz (New Zealand) for additional information.



Specifications

Certificated accordance with FCC Rules and Regulations Part 15 Subpart C as of date of manufacture.

Dynamic Allocation	Capacity
Systems :	500 max
Groups :	20 per system
Site :	1000 max (All) 256 per system
Channels :	up to 6000 (3000 typical)
Channels per Trunked System :	up to 250
Band Coverage :	14 Bands
Frequency Range :	

Frequency Range (MHz):

25.0 - 27.995
137.0 - 147.995
Above bands in 5 kHz steps
400.0 - 512.0
Above band in 6.25 kHz steps
28.0 - 69.990
Above band in 10 kHz steps
70.0 - 87.9875
108.0 - 136.9875
148.0 - 173.9875
764.0 - 775.9875
794.0 - 805.9875
806.0 - 956.0
1240.0 - 1300.0
Above bands in 12.5 kHz steps
225.0 - 399.95
Above band in 25 kHz steps
88.0 - 107.90
174.0 - 224.90
Above bands in 100 kHz steps

Features, specifications, and availability of optional accessories are all subject to change without notice.



Sensitivity (nominal) 12dB SINAD :

0.4 μ V	25 - 27.995 MHz	AM
0.3 μ V	28 - 53.98 MHz	FM
0.3 μ V	54 - 71.95 MHz	FM
0.3 μ V	72 - 75.995 MHz	FM
0.6 μ V	76 - 107.9 MHz	WFM/FMB
0.4 μ V	108 - 136.9875 MHz	AM
0.3 μ V	137 - 173.9875 MHz	FM
0.6 μ V	174 - 224.9 MHz	WFM
0.4 μ V	225 - 399.95 MHz	AM
0.4 μ V	400 - 512 MHz	NFM
0.4 μ V	764 - 775.9875 MHz	NFM
0.3 μ V	794 - 805.9875 MHz	NFM
0.4 μ V	806 - 956 MHz	NFM
0.7 μ V	1240 - 1300 MHz	NFM

Attenuation :	20dB nominal
Scan Rate :	100 channels per second (Conventional mode) max
Search Rate :	300 steps per second (5 kHz step only) max
Audio Output :	2.6W nominal into 8 Ω speaker 30mW nominal into 32 Ω stereo headphone:
Power Requirements :	DC 11.0V to 16.6V AC Adapter (AAD-996S) or Cigarette Lighter Cord or DC Cord with Orange Wire
External Jacks :	
Antenna Jack	BNC Type
Phone Jack	3.5mm Stereo Type
Ext. Speaker Jack	3.5mm Monaural Type
REC. Out Jack	3.5mm Stereo Type
DC Power Jack	5.5mm Center Positive



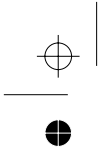

Remote Interface Jack	4pin Mini Type
GPS / Remote Interface Jack	D-sub 9pin Male Type
Ext. DC Power / ORNG Wire Jack	3pin (Center Orange Wire)
Operating Temperature :	Nominal -20°C to +60°C Close Call -10°C to +60°C
Size :	7.2 in. (W) x 5.9 in. (D) x 2.2 in. (H)
Weight :	3.46 lbs (without Mounting Bracket)

Features, specifications, and availability of optional accessories are all subject to change without notice.

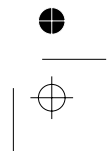
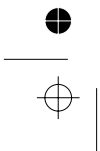
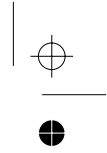

Reference

Preset Fleet Maps

Note: Size Codes in parenthesis indicates that the Size Code spans more than one block.

Preset Map 1

Block	Size Code
0	Size Code 11
1	Size Code 11
2	Size Code 11
3	Size Code 11
4	Size Code 11
5	Size Code 11
6	Size Code 11
7	Size Code 11

Preset Map 2

Block	Size Code
0	Size Code 4
1	Size Code 4
2	Size Code 4
3	Size Code 4
4	Size Code 4
5	Size Code 4
6	Size Code 4
7	Size Code 4

Preset Map 3

Block	Size Code
0	Size Code 4
1	Size Code 4
2	Size Code 4
3	Size Code 4
4	Size Code 4
5	Size Code 4
6	Size Code 12
7	(Size Code 12)

Preset Map 4

Block	Size Code
0	Size Code 12
1	(Size Code 12)
2	Size Code 4
3	Size Code 4
4	Size Code 4
5	Size Code 4
6	Size Code 4
7	Size Code 4

Preset Map 5

Block	Size Code
0	Size Code 4
1	Size Code 4
2	Size Code 12
3	(Size Code 12)
4	Size Code 4
5	Size Code 4
6	Size Code 4
7	Size Code 4

Preset Map 6

Block	Size Code
0	Size Code 3
1	Size Code 10
2	Size Code 4
3	Size Code 4
4	Size Code 12
5	(Size Code 12)
6	Size Code 12
7	(Size Code 12)



Preset Map 7

Block	Size Code
0	Size Code 10
1	Size Code 10
2	Size Code 11
3	Size Code 4
4	Size Code 4
5	Size Code 4
6	Size Code 4
7	Size Code 4

Preset Map 8

Block	Size Code
0	Size Code 1
1	Size Code 1
2	Size Code 2
3	Size Code 2
4	Size Code 3
5	Size Code 3
6	Size Code 4
7	Size Code 4

Preset Map 9

Block	Size Code
0	Size Code 4
1	Size Code 4
2	Size Code 0
3	Size Code 0
4	Size Code 0
5	Size Code 0
6	Size Code 0
7	Size Code 0

Preset Map 10

Block	Size Code
0	Size Code 0
1	Size Code 0
2	Size Code 0
3	Size Code 0
4	Size Code 0
5	Size Code 0
6	Size Code 4
7	Size Code 4

Preset Map 11

Block	Size Code
0	Size Code 4
1	Size Code 0
2	Size Code 0
3	Size Code 0
4	Size Code 0
5	Size Code 0
6	Size Code 0
7	Size Code 0

Preset Map 12

Block	Size Code
0	Size Code 0
1	Size Code 0
2	Size Code 0
3	Size Code 0
4	Size Code 0
5	Size Code 0
6	Size Code 0
7	Size Code 4

Preset Map 13

Block	Size Code
0	Size Code 3
1	Size Code 3
2	Size Code 11
3	Size Code 4
4	Size Code 4
5	Size Code 0
6	Size Code 0
7	Size Code 0

Preset Map 14

Block	Size Code
0	Size Code 4
1	Size Code 3
2	Size Code 10
3	Size Code 4
4	Size Code 4
5	Size Code 4
6	Size Code 12
7	(Size Code 12)





Preset Map 15

Block	Size Code
0	Size Code 4
1	Size Code 4
2	Size Code 4
3	Size Code 11
4	Size Code 11
5	Size Code 0
6	Size Code 12
7	(Size Code 12)

Preset Map 16

Block	Size Code
0	Size Code 3
1	Size Code 10
2	Size Code 10
3	Size Code 11
4	Size Code 0
5	Size Code 0
6	Size Code 12
7	(Size Code 12)

User Defined Fleet Maps

Type I Programming Information

When a Type I system is designed, the address information for all the ID's is divided into 8 equal sized blocks, numbered 0–7. When you program your scanner to track a Type I system, you must select a size code for each of these blocks. When you have assigned a size code to all 8 blocks, you'll have defined the fleet map for the system you are tracking. Each size code determines the number of fleets, subfleets, and ID's each block will have. For example, a size code of S-4 has one fleet, which is divided into 16 separate subfleets, and it has a total of 512 individual ID's.

When a block is assigned a size code, the fleet or fleets created within the block are assigned a Type I ID. The way these ID's display on your scanner depend on the block number and the block's size code. When a Type I ID appears, the leftmost digit represents the block which contains the ID.

The next 2-3 digits identify which fleet is active, and the last digit(s) identifies the subfleet.

The details concerning how the size codes are selected by a Type I System designer are highly dependent on the specific needs of the system's users. Some organizations might want many subfleets with only a few radios each, while another organization might want only a few subfleets with many radios each. Your task is to program your fleet map with the same size code assignments as the trunked system. If you do this accurately, you'll track all the Fleet-Subfleet combinations used by the system. In other words, you'll hear complete communications while monitoring a trunked system.

If you don't already know the size codes used, you'll have to guess at them. But since you don't have to figure out all the blocks at once, this isn't as hard as it



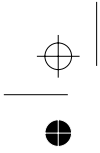

seems. Select a size code for a block, and then press **Scan**. Now listen to the communications. If you decide you are receiving most of the replies to the conversations with ID's assigned to the block you just programmed, then you've probably selected the right size code and can work on the next block of the map.

Finally, for most public safety systems there are some size codes which are more common. S-3 and S-4 are probably the most common, followed by S-10, S-11, and S-12.

Size Code Restrictions

If you select size code S-12, S-13, or S-14, there are some restrictions as to which blocks can be used for these codes.

S-12 can only be assigned to Blocks 0, 2, 4, or 6.

S-13 can only be assigned to Blocks 0 and 4.

S-14 can only be assigned to Block 0.

Since these size codes require multiple blocks, you will be prompted for the next available block when programming a fleet map. For example, if you assign Block 0 as an S-12, you will be prompted for b2, the next block available, instead of b1. And if you assign Block 0 as an S-14, you would not see another prompt because it uses all available blocks.

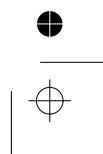
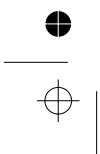
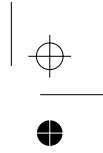

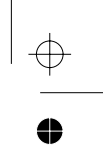
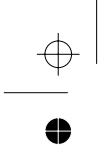

This page is intentionally blank.

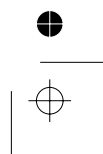
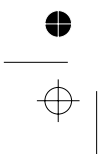

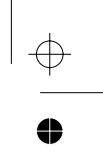
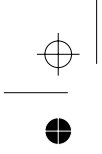

This page is intentionally blank.

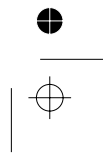
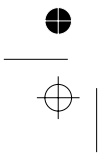



CTCSS Frequencies

67.0	69.3	71.9	74.4	77.0	79.7
82.5	85.4	88.5	91.5	94.8	97.4
100.0	103.5	107.2	110.9	114.8	118.8
123.0	127.3	131.8	136.5	141.3	146.2
151.4	156.7	159.8	162.2	165.5	167.9
171.3	173.8	177.3	179.9	183.5	186.2
189.9	192.8	196.6	199.5	203.5	206.5
210.7	218.1	225.7	229.1	233.6	241.8
		250.3	254.1		

DCS Codes

023	025	026	031	032	036	043	047
051	053	054	065	071	072	073	074
114	115	116	122	125	131	132	134
143	145	152	155	156	162	165	172
174	205	212	223	225	226	243	244
245	246	251	252	255	261	263	265
266	271	274	306	311	315	325	331
332	343	346	351	356	364	365	371
411	412	413	423	431	432	445	446
452	454	455	462	464	465	466	503
506	516	523	526	532	546	565	606
612	624	627	631	632	654	662	664
703	712	723	731	732	734	743	754



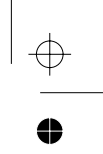
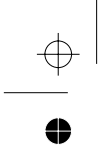

This page is intentionally blank.

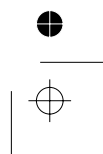
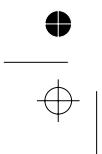

Index

A

Alert13, 14, 15, 41, 64, 66,
73, 90, 101, 102, 111,
112, 113, 115, 119, 120,
121, 122
Antenna30, 33, 37, 130
APCO14, 15, 24, 26, 40, 52,
67, 77, 87, 109
Attenuator13, 65, 66, 79, 89, 95,
97, 104, 108, 116
Auto Store11, 16, 98, 99, 100, 101,
104, 107

B

Backlight14, 40, 55, 56
Band65, 80, 81, 102, 106,
129, 130
Beep56, 101, 120, 121
Birdies125
Broadcast12, 13, 23, 89, 92, 96,
97, 104, 105, 106, 108,
111, 129

C

Channel12, 13, 14, 15, 21, 26,
27, 33, 41, 42, 44, 47,
49, 51, 66, 67, 70, 74,
75, 76, 79, 81, 83, 84,
85, 86, 87, 88, 89, 90,
91, 97, 129
Clone16, 20, 54, 60
Close Call3, 12, 13, 17, 40, 41, 42,
43, 44, 54, 100, 101,
102, 103, 104, 105, 106,
107, 108, 109, 131
Contrast57
Control Channel15, 79
Conventional16, 23, 24, 45, 46, 52,
62, 66, 67, 68, 70, 71, 98
Copy54, 63, 66, 76, 91
CTCSS13, 15, 22, 23, 44, 87,
88, 138

Custom13, 15, 40, 42, 46, 71,
93, 94, 97, 98, 104, 106,
107

D

Dangerous Road 119, 120, 121, 122, 123,
124
Dangerous Xing 119, 120, 121,
122, 123, 124
Data63, 70, 95, 104, 108,
136
Data Skip14, 63, 70, 95, 104, 108
DCS13, 15, 22, 23, 44, 87,
88, 138
Delay13, 63, 70, 95, 96, 104,
109, 115
Delete42, 63, 65, 66, 76, 83,
85, 91, 120, 121
Dimmer55
DIN-E30, 31, 33, 34, 36
Display14, 15, 37, 41, 42, 44,
51, 57, 122, 123
DND100, 101

E

Earphone37
EDACS3, 14, 24, 25, 26, 27, 29,
50, 62, 63, 65, 66, 67,
68, 72, 73, 76, 77, 78,
80, 84, 99, 127, 128
Edit, Editing
Group16, 28, 41, 42, 44, 49, 50,
51, 63, 73, 83, 84, 85, 86,
87, 88, 89, 90, 91, 112
Name18, 40, 42, 44, 51, 63, 65,
66, 67, 68, 76, 77, 83, 85,
86, 94, 113, 114, 119, 120
Site16, 44, 45, 63, 65, 76, 77,
78, 79, 80, 81, 82, 83
System16, 18, 19, 20, 22, 28, 40,
41, 44, 45, 46, 47, 48, 49,
52, 54, 63, 66, 67, 68, 69,
70, 71, 72, 73, 74, 75, 76,
77, 78, 79, 80, 81, 82, 83,

84, 85, 86, 87, 88, 89, 90,
91, 96, 98, 99, 104, 112,
129, 134
System Option63
End Code63, 72

F

FCC 129
Firmware59
Fleet26, 27, 63, 71, 132, 134
Func17, 21, 39, 40, 41, 42, 43,
47, 48, 51, 52, 101, 114,
119, 122, 136

G

GPS15, 35, 36, 40, 41, 42, 43,
54, 57, 58, 59, 71, 82, 97,
117, 118, 119, 122, 123,
124, 131
Group16, 28, 41, 42, 44, 49, 50,
51, 63, 73, 83, 84, 85, 86,
87, 88, 89, 90, 91, 112

H

Hits102, 103, 104
Hold17, 40, 41, 42, 43, 44, 46,
49, 63, 65, 70, 80, 95, 96,
103, 110, 116, 123, 124

I

I-Call29, 64, 72, 73
ID Scan43, 48, 49, 63, 70
Indicators42, 50
Install35
ISO31, 36, 37

L

L/O17, 48, 64, 69, 71, 74, 80,
82, 85, 91, 94, 95, 104,
105, 121
LCN26, 27, 78
Location15, 54, 71, 82, 117,
119, 120, 121, 123,
125
Lockout13, 14, 17, 41, 63, 65,

66, 69, 79, 80, 84, 85,
88, 91, 93, 95, 103,
120, 121, 136
LTR3, 14, 24, 25, 27, 28,
62, 63, 66, 67, 68, 76,
78, 80, 84, 127, 128

M

Menu17, 18, 40, 41, 43, 54,
110, 120
Modulation11, 44, 65, 66, 79, 88,
95, 104, 107, 115, 116
Motorola Trunking25
Multi-Site14, 28

O

Options63, 68, 100, 104, 120,
136

P

P2552, 63, 64, 65, 66, 67,
68, 75, 77, 81, 82, 83,
88, 95, 104, 109, 110
PC16, 30, 33, 59, 60,
109, 126
POI15, 119, 120, 121,
122, 123, 124
Port58, 59, 61
Power3, 14, 34, 35, 130, 131
Preprogrammed12, 19, 47,
136, 137
Priority15, 16, 40, 41, 44, 54,
66, 89, 90, 101, 110,
113
Programming ...17, 54, 55, 62, 66, 67,
68, 75, 76, 83, 85, 112

Q

Quick Key21, 28, 41, 42, 44, 46,
47, 63, 65, 68, 69, 77,
78, 84, 95, 96, 102,
103, 136, 137

R

Record 14, 64, 66, 74, 90, 95,
97, 104, 109

S

Scan, Scanning

Channels16, 48, 49, 84, 85, 99,
110, 129

Frequencies ..12, 16, 17, 65, 78, 86,
104, 105, 106, 138

Location Based GPS ..119

Systems3, 11, 12, 16, 22, 25, 28,
29, 46, 47, 48, 66, 67, 76,
79, 136, 137

SCAT14, 24, 26, 27, 63, 65, 67,
76, 80, 84, 99

Scroll Control11, 17, 18, 39, 40, 43, 47,
48, 49, 50, 53, 54, 56, 57,
68, 76, 77, 84, 86, 92, 94,
96, 98, 100, 101, 102,
105, 106, 111, 113, 114,
115, 120, 121, 122, 123,
136

Search, Searching

Close Call3, 12, 13, 17, 40, 41, 42,
43, 44, 54, 100, 101,
102, 103, 104, 105,
106, 107, 108,
109, 131

CTCSS/DCS .15, 22, 87, 88, 104, 105

Custom13, 15, 40, 42, 46, 71, 93,
94, 97, 98, 104, 106, 107

Delay13, 63, 70, 95, 96, 104,
109, 115

Frequency11, 13, 14, 16, 17, 44, 66,
78, 81, 86, 109, 114, 115,
116, 129

Hold17, 40, 41, 42, 43, 44, 46,
49, 63, 65, 70, 80, 95, 96,
103, 110, 116, 123, 124

Lockouts74, 104, 105

Range15, 40, 45, 71, 82, 94, 97,
117, 120, 122, 124, 129

Service12, 15, 20, 30, 45, 60, 92,
96, 97, 104, 112, 125,
128, 130, 145

Subaudible Tones105

Simplex23

Site16, 44, 45, 63, 65, 76, 77,
78, 79, 80, 81, 82, 83

Squelch13, 22, 40, 45

Startup Configuration14, 28

Step11, 14, 81, 95, 104, 109,
129

System16, 18, 19, 20, 22, 28, 40,
41, 44, 45, 46, 47, 48, 49,
52, 54, 63, 66, 67, 68, 69,
70, 71, 72, 73, 74, 75, 76,
77, 78, 79, 80, 81, 82, 83,
84, 85, 86, 87, 88, 89, 90,
91, 96, 98, 99, 104, 112,
129, 134

T

TGID16, 25, 42, 48, 49, 62, 66,
87, 99

Tone-Out13, 40, 42, 43, 54, 114,
116

Trunk3, 11, 14, 24

Type I24, 26, 67, 71, 72, 73, 77,
134

Type II24, 26, 67, 77

U

Unlock74, 105

V

Vehicle14, 33

Volume40, 120, 121, 122

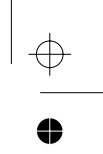
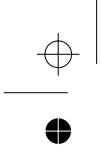

This page is intentionally blank.

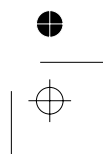
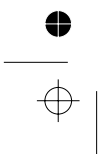



One-Year Limited Warranty



UNIDEN UBCD996T Scanning Receiver

IMPORTANT: Evidence of the original purchase is required for warranty service.

WARRANTOR: Uniden Australia Pty Ltd. ABN 58 001 865 498
Uniden New Zealand Limited.

Warranty only available in original country of purchase.

ELEMENT OF WARRANTY:

Uniden warrants to the original retail owner for the duration of this warranty, its UBCD996T (herein after referred to as the Product), to be free from defects in materials and craftsmanship with only the limitations or exclusions set out below.

WARRANTY DURATION:

This warranty to the original retail owner only, shall terminate and be of no further effect 1year (12 months) after the date of original retail sale. This warranty will be deemed invalid if the Product is;

- (A) Damaged or not maintained as reasonable and necessary,
- (B) Modified, altered or used as part of any conversion kits, subassemblies, or any configurations not sold by Uniden,
- (C) Improperly installed,
- (D) Repaired by someone other than an authorized Uniden Repair Agent for a defect or malfunction covered by this warranty,
- (E) Used in conjunction with any equipment or parts or as part of a system not manufactured by Uniden, or
- (F) Where the Serial Number label of the product has been removed or damaged beyond recognition.

Warranty only valid in the country of original retail/sale.

PARTS COVERED:

This warranty covers for one (1) year, the Product and included accessories.

STATEMENT OF REMEDY:

In the event that the Product does not conform to this warranty at any time while this warranty is in effect, the warrantor at its discretion, will repair the defect or replace the Product and return it to you without charge for parts or service. This warranty does not provide for reimbursement or payment of incidental or consequential damages. This EXPRESS WARRANTY is in addition to and does not in any way affect your rights under the TRADE PRACTICES ACT 1974 (Cth) (Australia) or the CONSUMER GUARANTEES ACT (New Zealand).

PROCEDURE FOR OBTAINING PERFORMANCE OR WARRANTY:

In the event that the Product does not conform to this warranty, the Product should be shipped or delivered, freight pre-paid, with evidence of original purchase (e.g. a copy of the sales docket), to the warrantor at:

UNIDEN AUSTRALIA PTY LIMITED
SERVICE DIVISION
345 Princes Highway,
Rockdale,
NSW 2216,
AUSTRALIA
Fax: (02) 9599 3278
www.uniden.com.au

UNIDEN NEW ZEALAND LIMITED
SERVICE DIVISION
150 Harris Road,
East Tamaki,
Auckland,
NEW ZEALAND
Fax: (09) 274 4253
www.uniden.co.nz

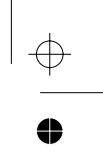
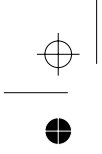

This page is intentionally blank.

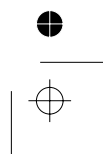
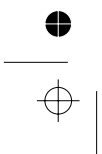

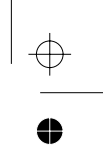
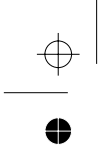

MEMO

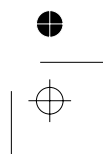
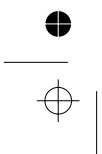

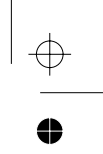
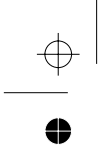

MEMO

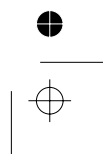
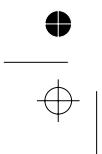



Uniden®

©2007 Uniden Australia Pty Limited, Uniden New Zealand Limited.
Printed in China.
UBZZ01335AA(0)